

GEELY



OWNER'S MANUAL
GEOMETRY | C

Preface

Dear customer,

Thank you for your trust in GEELY and thank you for choosing GEELY automobile which will provide you with excellent performance in safety, comfort, power, and fuel-economy. We hope to bring happiness and fun to your work and life with our premium products and services.

Please read and follow the contents of the Manual before using the vehicle so as to help you better understand and use Geely automobiles and ensure that your vehicle is always in good technological state and maintain best performance in your future use. The more you know about your vehicle, the more you can enjoy the safety and fun of driving it.

If you find any problems in use, please contact Geely Service for maintenance as soon as possible. You will be provided with high-quality services in vehicle maintenance and repair. Please be sure to maintain your car on schedule in accordance with the requirements in this Manual.

This Manual is an integral part of the vehicle. When selling or lending the vehicle, please forward this manual to the new owner.

Happy Life, Geely Drive!

Geely Automobile International Corporation (GAIC)

February 2023

All Rights Reserved. Without the written permission of GAIC, this Manual cannot be reproduced or copied in whole or in part.

Note: The cover and pictures in the manual are only for reference. All the pictures shall be subject to the actual devices on the vehicle.

Contents

Notes to users

5 About this Manual

- 5 Notes to users
- 8 Prompt message
- 8 Graphics

9 Vehicle identification

- 9 Appearance overview
- 10 Interior overview
- 11 Overview of front engine compartment
- 12 Overview of high-voltage system

Entering and leaving

13 Key and anti-theft

- 13 Smart key
- 14 Drive motor anti-theft

14 Vehicle locking and unlocking

- 14 Keyless locking and unlocking
- 16 Remote locking and unlocking
- 16 Central control locking and unlocking
- 16 Automatic locking and unlocking
- 17 Door handle unlocking
- 17 Trunk door open
- 18 Child safety lock

19 Start button

- 19 Power supply mode

Vehicle description

21 Seat

- 21 Front seats
- 23 Rear seats
- 24 Seat heating/ventilation*
- 25 Driver seat memory function*

27 Instrument cluster

- 27 Instrument Cluster Overview
- 31 Warnings and indicators

35 Head up display (HUD)*

- 35 Heads up display (HUD)

37 Air conditioner

- 37 Front A/C control system
- 41 Air vent adjustment
- 42 A/C settings
- 42 Air monitoring system*

43 Light and wiper

- 43 Light control combination switch
- 45 Wiper control combination switch
- 47 Interior lighting
- 48 Outdoor lamp

49 Steering wheel

- 49 Horn
- 49 Steering wheel adjustment
- 49 Steering wheel button

51 Rearview mirrors

- 51 Exterior Rearview Mirror
- 54 Interior rearview mirror

55 Window

- 55 Power window

1

2

3

4

5

6

7

8

57 Sunroof*

57 Panoramic sunroof

58 Sun visor

58 Sun visor and makeup mirror

59 Storage space

59 Front storage

61 Rear storage

62 Trunk storage

63 In-vehicle power supply

63 Wired charging

63 Wireless charging*

64 Luggage rack

64 Luggage rack*

Safe travel

65 Seat belt

65 Seat belt overview

66 Three-point seat belt

69 Airbag

69 Airbag overview

69 Positions of airbags

72 Deployment of airbag

74 Child restraint system

74 Selection of child safety device

76 Use of child restraint system

77 Installation of child restraint system

Starting and driving

81 Driving

81 Driving instructions

84 Vehicle start

84 Starting procedures

85 Gearshift operation

85 Gear information

85 Shift

86 Driving mode

86 Driving mode

87 Intelligent driving system

87 Intelligent driving system introduction

87 Cruise control system (CC)

89 Automatic speed limit control system (LIM)

91 Adaptive cruise control system (ACC)*

100 Intelligent cruise control system (ICC) *

107 Lane keeping assist (LKA)*

110 Automatic emergency braking system (AEB) *

116 Rear side radar assist system*

119 Intelligent high beam control system (IHBC)*

121 Driver assist system

121 Service brake

121 Recuperating

122 Parking brake

124 Anti-lock braking system (ABS)

124 Electronic braking-force distribution (EBD)

125 Electronic stability control (ESC) system

- 125 Hydraulic brake assist (HBA)
- 126 Traction control system (TCS)
- 126 Hill hold control (HHC)
- 126 Hill descent control (HDC)
- 127 Electric power steering (EPS)

127 Park assist system

- 127 Park assist system
- 128 Reversing visual system
- 130 Panoramic image system*

132 Vehicle charging

- 132 Charging precautions
- 132 Charging operation

Emergency

137 Emergency equipment

- 137 Hazard warning lamp
- 137 Reflective vest
- 137 Warning triangle
- 138 First aid kit
- 138 Fire extinguisher

139 Emergency unlocking

- 139 Emergency unlocking door
- 139 Emergency unlocking trunk door
- 140 Emergency unlocking charger

141 Replace the key battery

- 141 Replace the key battery

142 Jumper starting

- 142 Jumper starting

143 Vehicle towing

- 143 Towing tips

- 143 Towing eye

145 Replacement of spare tire

- 145 Replacement of spare tire

148 Replacement of fuse

- 148 Inspection or replacement of fuse
- 149 Front engine compartment fuse box
- 152 Interior fuse box

155 Replacement of bulb

- 155 Replacement of bulb

156 Emergency handling

- 156 Drive motor or motor controller overheating
- 156 Vehicle fire
- 157 Getting vehicle out of trap
- 157 Emergency response to road accidents*

Repair and maintenance

159 Maintenance instruction

- 159 Regular maintenance

159 Oils and fluids

- 159 Open and close the front engine hood
- 160 Coolant
- 162 Brake fluid
- 162 Washer fluid

163 Wiper blades

- 163 Replacement of wiper blade

165 Low voltage battery

1

2

3

4

5

6

7

8

165 Maintenance of low-voltage
battery

166 Power battery

166 Power battery

167 Tire

167 Tire maintenance

171 Vehicle cleaning

171 Exterior cleaning

172 Interior cleaning

Technical information

175 Vehicle identification

175 Vehicle identification number

175 Vehicle certification label

176 Driving motor code

177 Technical parameters

177 Main dimensions and
parameters

177 Mass parameters of the vehicle

177 Power efficiency of the vehicle

178 Drive motor parameters

178 Power battery parameters

178 Tire parameters

179 Wheel alignment parameters

180 Recommended fluids

180 Recommended Liquids and
Volume

About this Manual

Notes to users

Manual use statement

- The multimedia manual, an important part of this Manual, is used to introduce the entertainment system of the vehicle. See the multimedia manual for detailed operations of the entertainment system.
- All the information in this Manual is the latest information as of the time of publication. The content of this Manual is based on the product information at the time of publication. In order to meet the needs of customers and meet the requirements of laws and regulations, the vehicle configuration and performance will continue to be optimized and improved. Your vehicle may be different from the description in this Manual.
- The software version of the vehicle and settings may be updated later. Before the upgrade, you will be informed to obtain your consent. The information displayed after the upgrade may be different from the description in the user manual delivered with the purchased vehicle. The actual situation shall prevail in terms of specific information.

Vehicle overview

- This is a pure electric vehicle, which is different from traditional fuel vehicles. Please read the instructions in this Manual carefully before the first operation. Otherwise, it will cause personal injury and property damage, and may also cause you to lose your maintenance or warranty rights.

- This vehicle is equipped with a lithium-ion power battery pack (power battery) to store electric energy. Try to keep the power battery fully charged before driving. During vehicle driving, the power battery is in a gradual discharge state. When the power battery is low, the power battery must be charged, otherwise the vehicle cannot be driven.
- This vehicle is equipped with two types of batteries: one is the power battery (high voltage), which supplies power to the drive motor to drive the vehicle; the other is a 12 V battery, which is arranged in the front cabin. Its function is the same as that of the battery in traditional fuel vehicles. It supplies power to low-voltage electrical systems such as headlights and stereos. The power of the 12 V battery comes from the power battery.
- The vehicle is equipped with a charging plug which is connected with the power grid to charge the power battery. In addition, when the vehicle is braked, part of the electric energy is stored in the power battery through the motor power generation so as to extend the vehicle endurance mileage, which is called energy recovery.
- This vehicle has creeping function, that is, when the vehicle is in a driving state (READY indicator is on), when the vehicle is placed in the forward (D) or reverse (R) gear, release the brake pedal and parking brake, and the vehicle will slowly move forward or backward.

1

2

3

4

5

6

7

8

High voltage safety

The following information can protect the safety of occupants and first-aid personnel in the vehicle from high-voltage electricity:

- The high-voltage fuse (inside the power battery) provides short circuit protection for the power battery.
- The positive and negative high-voltage cables connected to the power battery are usually controlled by the high-voltage relay. When the vehicle high-voltage power supply is disconnected, the relay is disconnected to prevent current from flowing out of the power battery.
- The vehicle power supply can be reduced to the safe voltage for human touch only after 5 minutes of cutting off. To prevent serious injury or even death due to severe burns or electric shock, do not touch, cut off or damage any orange high-voltage cables or high-voltage components.
- Both positive and negative cables are insulated from the metal body. High voltage current will not flow through the metal body through these cables. As the metal body is insulated from high-voltage components, it is safe to touch the metal body.

Warning message

- In case of power system failure or user's improper operation, the combination instrument will automatically display warning message. Please read the message and follow its instructions. If the warning lamp is on, a warning message is displayed. Or if the battery fails, the power system may not be started. In this

case, try to start the system again. If the ready for operation indicator is not on, contact Geely Service for maintenance as soon as possible.

- When the impact sensor detects a certain degree of impact, the system and high-voltage current output will be cut off in an emergency to minimize the risk of electric shock. If the emergency cut-off system is activated, the vehicle cannot be restarted. To restart the vehicle, contact Geely Service for maintenance.



This vehicle is equipped with high voltage DC and AC systems and 12 V low voltage system. High voltage DC and AC equipment systems are very dangerous and may cause serious casualties in case of failure. ◀

Important tips

- Please check tire wear and tire pressure regularly as per the methods recommended herein and tire pressure requirements.
- Always use the oil and fluid recommended in this manual and conduct maintenance as per the Warranty and Maintenance Manual.

Safety precautions

- The high voltage value of the vehicle is about 400V. Do not touch any high voltage components with bare hands without disconnecting the high voltage. High voltage components include: drive motor controller, power harness device, on-board charger, high voltage main cable, fast charging plug, fast charging socket, power battery, drive motor, slow

charging socket, slow charging plug, etc. The high-voltage cables in the vehicle are wrapped with orange bellows, so please pay attention to identification.

- Do not touch the positive and negative poles of the power battery box with both hands at any time.
- Never crush, puncture, burn or damage the battery system manually.
- Do not sell, transfer, modify or store any power battery without permission. Geely Service shall be responsible for recycling and removing the power battery from the scrapped vehicle according to the specified process to prevent safety accidents.
- When washing the vehicle, try not to aim the water gun at the connector at the bottom of the chassis for washing.
- The ambient temperature for vehicle parking shall be between - 30 °C and 55 °C, otherwise the vehicle may not be operated normally.
- This vehicle is equipped with an anti-lock braking system (ABS). In case of emergency braking, be sure to depress the brake pedal hard rather than make inching braking.
- This vehicle is equipped with airbags. For the safety of children, do not use any backward child restraint system on a seat with frontal airbag protection (activated).
- The vehicle operating environment shall be free of corrosive, explosive and insulating damaging gases or conductive dust, and shall be far away from heat sources.

- It is necessary to use and place foot mats with appropriate sizes properly. The foot mats shall not affect the normal use of each pedal so as to avoid affecting the action of the pedals due to the sliding of the foot pads and causing traffic accidents.

Accessories, spare parts and modifications

- For your driving safety, do not remove parts and components on your own.
- Refitting or adding devices is not allowed. Geely Auto assumes no responsibility for direct or indirect losses caused by the modification or addition of devices.
- Geely Auto is only responsible for the tested and certified original hardbound accessories and optional equipment. In order to ensure the vehicle performance and safety as much as possible, the original hardbound accessories of Geely Auto are preferred.

1

2

3

4

5

6

7

8

Prompt message

This Manual provides information on all models. Due to the variety of configurations and models, the descriptions in this manual may differ from the actual configuration of your vehicle. The vehicle you actually receive shall prevail.

Warning

 Ignoring the warning may cause serious injury or death. The stated steps or requirements must be strictly followed. ◀

High pressure

 Issues mentioned here are related to the high-voltage circuit of battery electric vehicles, which must be strictly observed; otherwise it may cause electric shock or more serious injury to death. ◀

Caution

 Steps and requirements stated in the notice must be strictly observed. Otherwise your vehicle might be damaged. ◀

Description

 Indicative descriptions for your better use of the vehicle information. ◀

Environment





 Issues described are related to environmental protection. ◀

Asterisk

The asterisk “*” symbol following a title or name indicates that the configuration or function described is only featured on

certain models. Your vehicle may not necessarily have it. ◀

Graphics

-  Describing an object.
-  Motion direction of an object.
-  Rotation direction of an object.
-  Behavior is prohibited or occurrence should be prevented.

Vehicle identification

Appearance overview

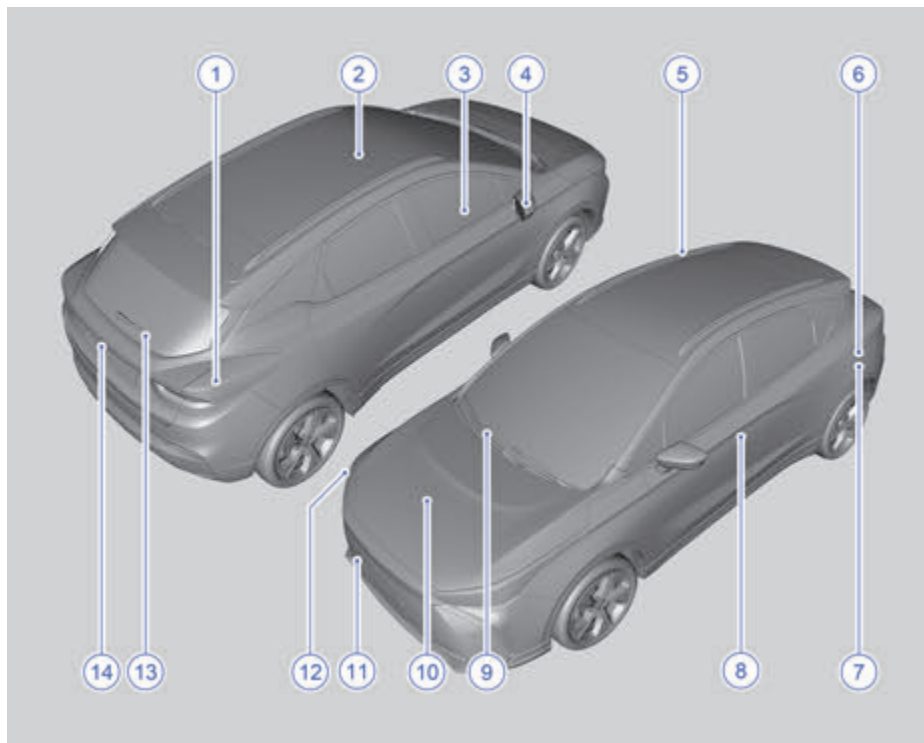

- | | |
|-----------------------------|-----------------------------------|
| 1. Rear combination lamps | 8. Exterior door handle |
| 2. Sunroof* | 9. Front Wipers |
| 3. Window | 10. Front engine compartment hood |
| 4. Exterior rearview mirror | 11. Front towing hook cover plate |
| 5. Luggage rack* | 12. Front combination lamps |
| 6. AC charging port | 13. Rear wiper |
| 7. DC charging port | 14. Tail gate |

1

2

3

4

5

6

7

8

Interior overview

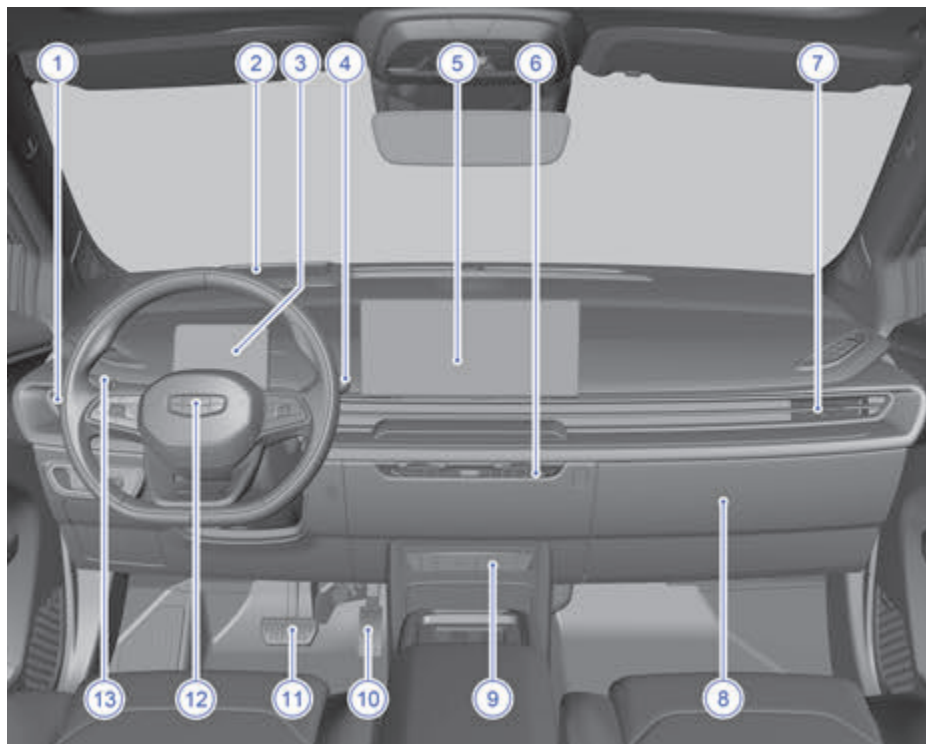

- | | |
|---------------------------|------------------------------------|
| 1. Left vent | 8. Glove box |
| 2. Head up display (HUD)* | 9. USB port |
| 3. Instrument display | 10. Accelerator pedal |
| 4. Shift lever | 11. Brake pedal |
| 5. Multimedia screen | 12. Steering wheel |
| 6. Central air vent | 13. Light/wiper combination switch |
| 7. Right vent | |

Overview of front engine compartment

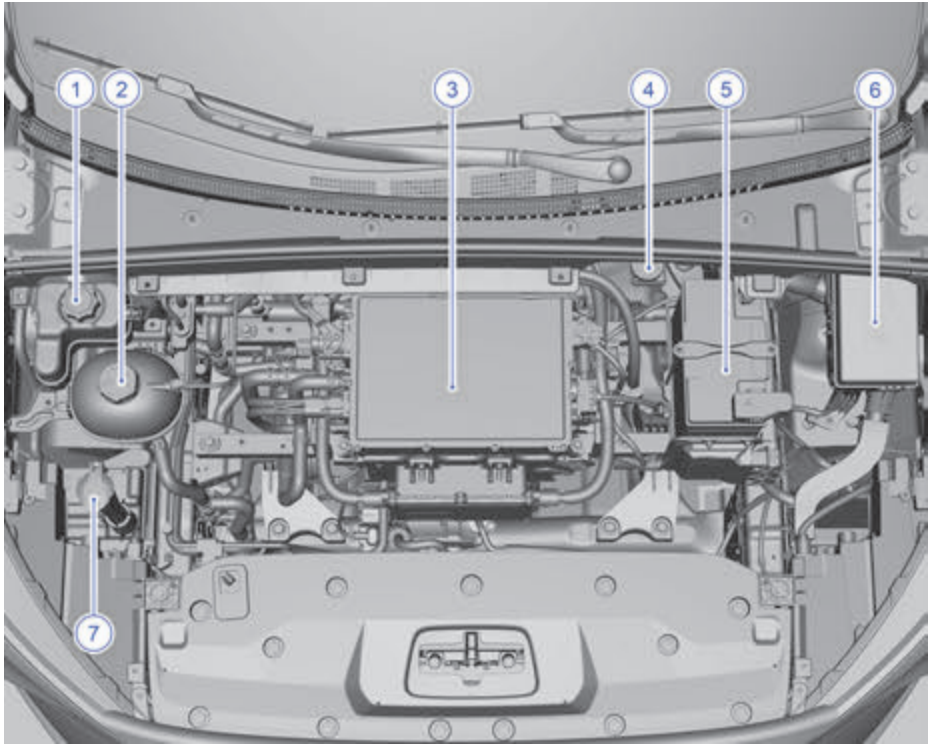

- | | | | |
|----|--|----|-----------------------------------|
| 1. | Coolant expansion tank for power battery | 5. | Battery |
| 2. | Coolant expansion tank for drive motor | 6. | Front engine compartment fuse box |
| 3. | High/low voltage charging system | 7. | Washer fluid reservoir assembly |
| 4. | Braking fluid reservoir | | |

1

2

3

4

5

6

7

8

Overview of high-voltage system

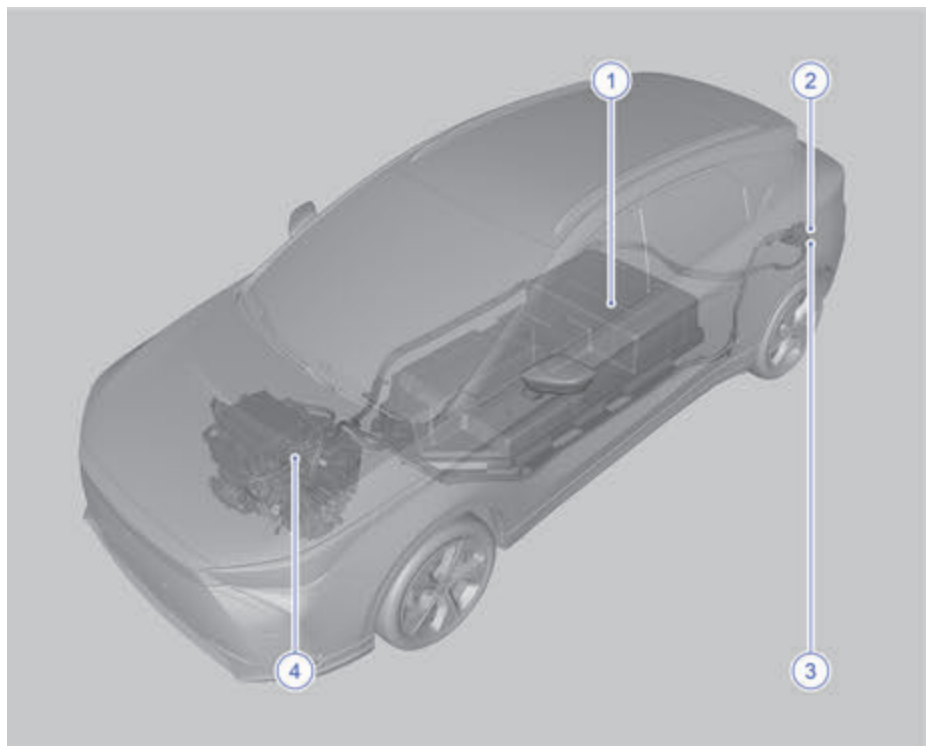

- 1. Power battery
- 2. AC charging port
- 3. DC charging port
- 4. Electric drive system

Key and anti-theft

Smart key

Introduction of key buttons

The smart key has been matched to the vehicle system. If the smart key is lost, damaged or stolen, contact Geely Service as soon as possible. The control functions such as starting, unlocking and locking will be canceled for the lost, damaged or stolen smart key. If the smart key is retrieved, its function can be activated again at Geely Service.

i The new smart key cannot be available immediately. It takes some time for Geely Service to match new a smart key with your vehicle. ◀



1. Locking button
2. Trunk unlocking button
3. Unlocking button
4. Vehicle locating button
5. Mechanical key

i When the vehicle position cannot be confirmed and the vehicle is in the anti-theft state, press the vehicle locating button of the smart key, the search function

will be activated, the turn signal flashes, and the horn beeps. ◀

▷ Please keep the backup smart key in a safe place and do not place it inside your vehicle.

Electronic disturbance of built-in anti-theft chip will make key system and anti-theft system work abnormally and as a result, the vehicle may be unable to be started. ◀

Take out the mechanical key

Press the button on the back of the smart key to take out the mechanical key.



▷ If the smart key is interfered by other signals, the vehicle may not be able to detect the key and fail to start, unlock, lock, etc.

- It is covered by metal shields, for example, the smart key and a metal shell mobile phone are placed together.
- When external devices and equipment are equipped with a standby power supply for operation, place the smart key beside the standby power supply or within the range of interference.
- Place the smart key next to electronic products with strong interference, such

1

2

3

4

5

6

7

8

as laptops, Bluetooth headsets, working power converters and chargers, Bluetooth access cards, walkie talkies and other devices with strong interference. ◀

Drive motor anti-theft

This vehicle is equipped with a passive anti-theft system. This system does not need to be manually activated or released. When the brake pedal is pressed and a valid smart key is found in the vehicle, the motor disable system will be automatically released.

If the following two methods fail to start the vehicle, your vehicle needs to be repaired. Please contact Geely Service for a new key.

- If the smart key does not appear to be damaged, try using another smart keys.



- Put the smart key in the glove box under the rear of the auxiliary instrument panel.

 Do not leave the smart keys or devices that can disable the anti-theft system in the vehicle. ◀

Vehicle locking and unlocking

Keyless locking and unlocking

Keyless locking

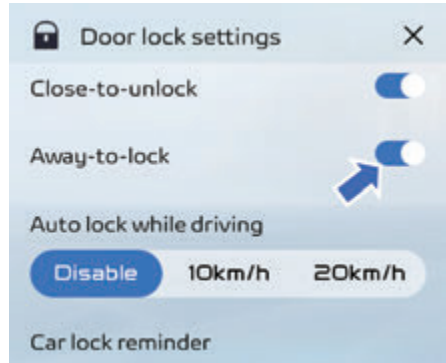

On the multimedia display screen, click Set up → Vehicle Setting → Door Lock in turn. In this interface, you can enable or disable the automatic locking function away from the vehicle, close all doors, take the legal key out of the vehicle search range, and the vehicle will be locked automatically without pressing the lock button on the smart key.

Keyless unlocking

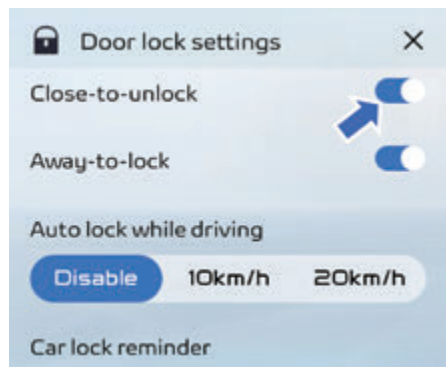

On the multimedia display screen, click Set up → Vehicle Setting → Door Lock in turn, and the automatic unlocking function near the vehicle can be enabled or disabled in this interface. Just bring the legal smart key into the vehicle search range, the vehicle will automatically unlock, and the door handle will pop up automatically. Pull the door handle, and the door will open.



Keyless locking fails if:

- The vehicle power supply is turned on.
- There is a door not closed.

When performing keyless locking, if you do not hear the locking sound and see the turn signal prompt, it means that the locking has failed, which may be due to the following reasons:

- When the vehicle is locked, and the trunk door is opened and then closed, if the smart key which is used for locking is left inside the trunk, the vehicle will not be locked. Prevent smart keys from being locked in the vehicle.
- To prevent misoperation, when the driver uses the front door handle to unlock, he needs to wait for 3 seconds before keyless locking; the keyless unlocking function becomes unavailable within 3 seconds of locking.
- There is a blind spot in the smart key detection. Do not put the smart key in the trunk, dashboard and other remote locations. ◀



- The remote control/smart key only works within a certain distance. Be aware that its working range may be affected sometimes by physical and geographical factors. For safety concern, it is necessary to check whether the operation succeeds when you lock vehicle with the remote key.
- When the vehicle is in a charging pile, a large parking lot, a substation, and other places with signal interference, or when the smart key is put together with the interference device, the smart key may be interfered. Consequently, abnormal key functions such as unlocking or locking abnormalities will be observed occasionally. If so, wait for 3 seconds before placing hand on the door handle unlocking or locking sensor area for unlocking or locking. ◀

Remote locking and unlocking

Remote locking

Press and release the locking button to lock the four doors, the horn will beep once, the turn signal turns on for a few seconds, the interior lamps are off and the audio entertainment system turns off. If any of the front compartment hood, front occupant side door, rear door or trunk door is not closed, when the locking button on the smart key is pressed, the horn will beep and the turn signal flashes to alert the user.

Remote unlocking

Press and release the unlocking button on the smart key to unlock the four doors, and the steering light flashes several times. Press and hold the trunk door unlocking button to unlock the trunk door.



Do not allow children enter the trunk. Ensure the trunk door is closed when vehicle is not attended. Once children are trapped in trunk, they may not get out and might get suffocated or heatstroke. ◀

Central control locking and unlocking



1. Unlocking button
2. Locking button

All doors will be unlocked if unlocking button is pressed when four doors are locked.

All doors will be locked if locking button is pressed when four doors are closed.



The unlocking by using central control buttons inside the vehicle can only be executed in the state that the anti-theft system is disabled. In other anti-theft states, the unlocking is impossible. ◀

Automatic locking and unlocking

Automatic re-locking

When the smart key unlocking button is pressed for 30 seconds, if any of the four doors or trunk door is not opened, the four doors are locked again automatically. The interior lamps turn off, and the anti-theft system is alarmed.

Automatic locking during driving

When the vehicle is at the READY state, the four doors will be locked automatically after the speed has been greater than the set speed for a certain period.

Automatic unlocking

After the vehicle is automatically locked, if the vehicle is stopped and the vehicle power is set to OFF, the door will be unlocked automatically.

Collision unlocking

In case of severe head-on collision in travel, the four doors are unlocked automatically so

that the occupants can leave the vehicle quickly.

Door handle unlocking

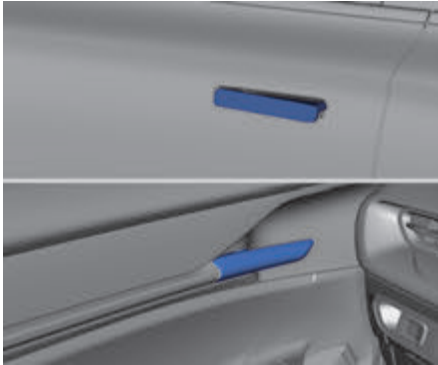

When doors are in unlocked state, the door can be opened by pulling interior/exterior handles of vehicle.

Trunk door open

Open the trunk door

 Open or close the trunk door slowly and gently by hand. Failure to do so may result in damage or loss of function of the trunk door. ◀

Open the trunk door from outside the vehicle

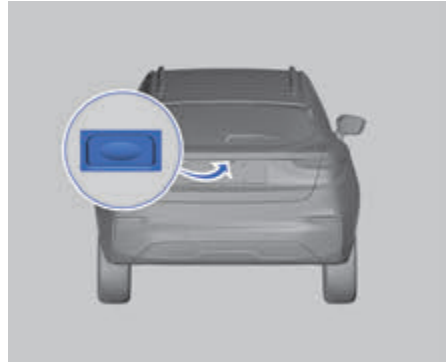

When the vehicle is stationary, the interior locking switch is in the unlocked state and the external anti-theft alarm system is in the disabled state, at this time, press the exterior trunk door switch to open the trunk door.

The vehicle is equipped with a keyless entry system. When the smart key is near the trunk door, press the external trunk door switch to open the trunk door when it is not disturbed.

1

2

3

4

5

6

7

8

Unlock the trunk door with the smart key



When the vehicle is stationary and the vehicle is locked, press and hold the trunk door unlocking button on the smart key to unlock the trunk door.

Child safety lock



The left and right rear doors are fitted with child safety locks. Please use child safety locks when left/right sides of rear seat are occupied by children.

The child safety lock switch is at the outer edge of each rear door. Insert the mechanical key into the child safety lock as shown in the figure and turn it in the direction of the arrow, and then the child

safety lock is in the OPEN position. The door cannot be opened from inside the vehicle, but can only be opened from outside the vehicle so as to ensure children's safety during driving.

 After setting the child's safety lock, be sure to test whether door can be opened from inside to ensure child safety lock is normally functioning. ◀

Start button

Power supply mode

The vehicle is equipped with an inductive starting system without a starting switch. To start the vehicle, the smart key matching the vehicle must be in the vehicle and detected. Vehicle power statuses can be divided into as follows:

ACC: use a smart key to unlock and open the driver's side door. If there is no other person at the driver's side, the power supply of the vehicle will be switched to ACC gear. At the same time, the vehicle will enter into Non-ready Mode at the high voltage. Then, partial functions of the vehicle are available, such as the infotainment system.

ON: the driver gets on the vehicle, and when he recognizes the legal key in the vehicle and steps down the brake pedal to shift the gear to the drive (D) or reverse (R) gear, the power supply of the whole vehicle is switched to the ON gear, the high voltage enters READY, and the vehicle can be driven normally.

OFF: After parking, the driver gets off. All doors are closed. Use remote control or polling to lock. The vehicle is powered down and shifted to OFF gear.

Power down in emergency

When the vehicle is abnormal and cannot be powered down by opening and closing the door, the following methods can be used for emergency power-down:

First, make sure the vehicle is stationary, then depress the brake pedal and press and hold the hazard warning lamp switch for

more than 7 seconds to power down to OFF.

1

2

3

4

5

6

7

8

Seat

Front seats

Front seat headrest adjustment



1. Press and hold the adjustment button under the seat headrest;
2. Lift up or press down the headrest to the required height, and then release the button;
3. Gently press or lift the headrest again until a click is heard, to ensure that the headrest is locked in place.

 Before the vehicle is driven, the head restraint must be correctly installed and adjusted so that its top is flush with the occupant's head. Otherwise, it may cause personal injury or death in the event of an accident. ◀

 Do not adjust seats while driving. So as not to lose control of the vehicle and thus cause personal injury or death. ◀

 The seat backrest should not be inclined too much during driving. Otherwise, it may cause personal injury or death in the event of a collision.

In the event of a vehicle accident, the seat belt can provide maximum protection only by maintaining the correct sitting posture. ◀

Power driver seat*

 Do not place any object under the power seat or obstruct the movement of the seat. Otherwise, the seat adjustment motor may be damaged. ◀

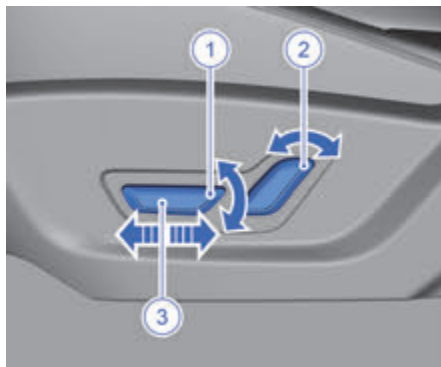

1. Move the rear end of the switch up/down to adjust the height of the seat cushion.
2. Move the switch forward/backward to adjust the angle of the seat backrest.
3. Move the switch forward/backward to adjust the front and rear position of the seat.

1

2

3

4

5

6

7

8

Manual driver seat



1. Forward and backward adjustment lever of seat

Hold the middle of the fore and aft adjusting rod and pull it upwards. Lean against the seat and slide the seat to the required position. Loosen the adjusting lever until a clicking sound is heard from the seat rail and the seat is locked.

2. Seat height adjustment handle

Lift up or press down the seat height adjusting handle to raise or lower the seat height. Adjust the seat to the required height and release the adjusting handle.

3. Adjusting handle of backrest angle

Lift the backrest angle adjusting handle to unlock the backrest. Gently press back or slowly leave the seat backrest to rotate it backward or forward to the required position. Lower the backrest angle adjusting handle to lock the backrest.

Power front passenger seat*

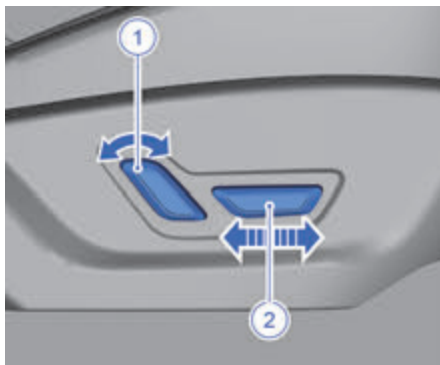

1. Move the switch forward/backward to adjust the angle of the seat backrest.
2. Move the switch forward/backward to adjust the front and rear position of the seat.

Manual front passenger seat



1. Adjusting handle of backrest angle.
2. Forward and backward adjustment lever of seat.

The manual adjustment method of the front passenger seat backrest angle and the front and rear of the seat is the same as that of the driver's seat.

Rear seats

Rear seat headrest adjustment

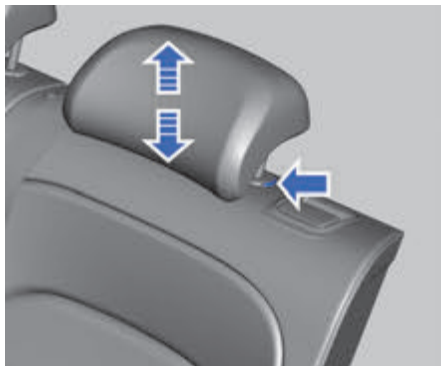

1. Press and hold the adjustment button under the seat headrest to move the headrest up and down;
2. Gently press or lift the headrest until you hear a click to ensure that the headrest locks in place.

i Press and hold the adjustment button to push inside or pull outside the headrest. ◀

Folding rear seat backrest

Rear seats consist of the left rear seat and the right rear seat, which features 4/6 folding function. The boot space is enlarged for the storage of big items.



1. Put the rear seat headrest to the lowest position;
2. Buckle the unlocking handle of the rear seat backrest;
3. Fully fold the seat backrest on the corresponding side.

After the seat backrests are folded, leave some space between the rear seat headrests and the front seats.

Unfolding rear seat backrest

Flip the backrest backward and push hard backward until the red mark on the corresponding unlocking handle disappears, so as to lock it. If not, the seat belt may not function normally.

! When the vehicle is driven, occupants are not allowed to sit on folded seats or in the boot. The seats should be properly used. When the seat backrest returns to the original position, the following precautions shall be considered to prevent injuries upon collision or emergency braking:

- Push the top of the seat backrest forward and backward to ensure that the seat back is firmly locked, or it will hinder the normal operation of the seat belt.

1

2

3

4

5

6

7

8

Vehicle description

- Make sure the seat belt is not twisted or stuck below the seat, but well positioned for use. ◀

▶ When the child restraint is placed in the rear seat, the child restraint and its installation guide sheath must be removed before the rear seat backrest folding function can be used. ◀

Seat heating/ventilation*

Front seat heating



1. On the multimedia display screen, click the buttons Air Conditioner → Seat → Seat Heating in turn, and select the seat heating function in this interface.
2. Click the heating adjustment button under the driver's seat or front passenger seat.

i The seat heating indicator indicates the gear status of the seat heating. When the first gear is on, it indicates that the seat heating is in the low gear. When the second gear is on, it indicates that the seat heating is in the high gear. When the AUTO gear is on, it indicates that the seat heating is in the automatic gear. When the seat

heating indicator is off, it indicates that the seat heating is off. ◀

! If your body can't feel pain or temperature due to drugs, paralysis, palsy or other diseases, please do not use the seat heating function. Otherwise, it may cause burns to the body. ◀





- Do not kneel on the seat or put the seat under concentrated load, to avoid damaging the elements of the seat heating unit.
- Do not clean the seat by wet washing.
- The seat heating function can only be enabled when the vehicle is in the READY state, which can greatly reduce the battery power consumption.
- If the power of the whole vehicle is too low, the seat heating function will be automatically disabled so that the vehicle has enough power.
- When the seat heating function is active, seat cushion must not be placed on the seat. ◀

Front seat ventilation



1. On the multimedia display screen, click the buttons Air Conditioner → Seat → Seat Ventilation in turn, and select to set the seat ventilation function in this interface.
2. Click the ventilation adjustment button under the driver's seat or front passenger seat.

 The seat ventilation indicator indicates the gear status of the seat ventilation. When the first gear is on, it indicates that the seat ventilation is in the low gear. When the second gear is on, it indicates that the seat ventilation is in the middle gear. When the 3 gear is on, it indicates that the seat ventilation is in the high gear. When the OFF gear indicator is off, it indicates that the seat ventilation is off. ◀

 On the same seat, seat heating and seat ventilation cannot run simultaneously. ◀

Driver seat memory function*



On the multimedia display screen, click the buttons Set up → Smart Cabin → Seat in turn, and select the seat memory function to store and retrieve memory information.

Operation methods

1. Adjust the driver's seat to the required position;
2. After pressing the M button, press one of the users 1-6 within 3 s, and the seat memory is completed.

 Do not adjust any seat during driving. Moving the seat during driving may get the vehicle out of control, resulting in collision and serious injuries. ◀

Easy access function for driver*

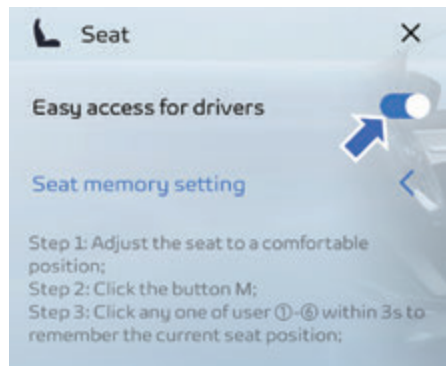

On the multimedia display screen, click the buttons Set up → Smart Cabin → Seat in turn, and select to enable or disable the easy access for driver in the interface.

- Easy out: open the driver's door and the driver's seat will automatically move backward, easy for the driver to get off.
- Easy in: when the driver enters the vehicle and closes the door, the driver's seat will automatically return to the position before getting off the vehicle.

 During the operation of comfort function, changing the state of the vehicle power supply and adjusting the seat

1

2

3

4

5

6

7

8

will interrupt the easy access function for the driver. ◀

Instrument cluster

Instrument Cluster Overview

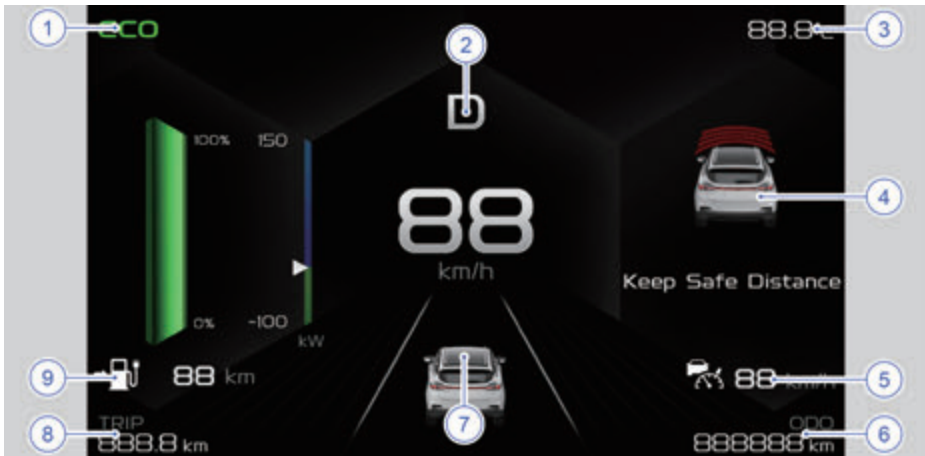

1. Driving mode

- According to the driving mode currently selected by the driver, it is displayed as ECO+, ECO and SPORT.

2. Gear display

- According to the gear currently selected by the driver, it is displayed as P, N, R and D.

3. Outside temperature

- It displays the temperature outside the vehicle, and the display range is - 40 °C ~60 °C.

4. Information display

- Graphic information of prompt and alarm.
- Some Trip Computer information (APC, IPC, TPMS).
- Fault inquiry.
- Menu settings.

5. LIM/adaptive cruise/smart navigation display

- The cruise speed and cruise and speed limit indicator are displayed in this area.

6.ODO

- It displays the total mileage that the vehicle has traveled.

7. Special function prompt

- It displays the indication information of lane keeping assistance, cruise control and other functions.

8.Tripmeter

- It displays the driving mileage of the vehicle since the last reset.

9. Endurance mileage

- It displays the mileage that the vehicle can travel with the current power.

 The display mode of combination instrument display can be set on the multimedia display. ◀

 Pictures in the interface of combination instrument are only for

1

2

3

4

5

6

7

8

Vehicle description

reference. All the pictures shall be subject to the actual devices on the vehicle. ◀

Display screen settings

 It is prohibited to adjust the combination instrument screen while the vehicle is running. ◀

 Be sure to activate steering wheel multiplex before setting combination instrument. ◀

Steering wheel button adjustment mode

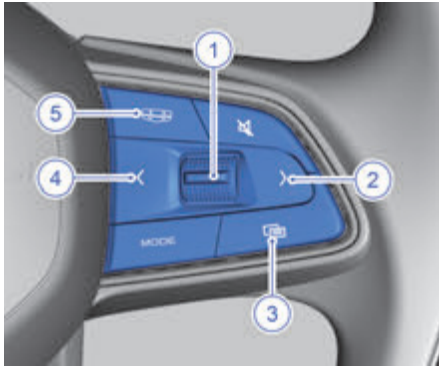

1. Up/down selection and confirmation button: press and release this button to select and execute the items in the highlighted area, or to shield the general alarm. Press and hold this button to reset the Trip Computer interface information. Move the button up or down to select the previous or next option.
2. Right selection button: press and release this button to select the right option.
3. Mode switch button: press and release this button to switch the control of

steering wheel keys on multimedia display and combination instrument

4. Left selection button: press and release this button to select the left option.
5. Return button: press and release this button to return to the previous menu.

Menu information

First-level menu	Second-level menu	Third-level menu	Fourth-level menu
APC			
IPC			
TPMS			
Fault inquiry			
Settings	Trip computer	Reset trip computers	Yes
			No
		Reset Tripmeter	Yes
			No
		Reset APC	Yes
			No
	Date	XX XX XX	
	Clock	XX: XX (hour value range: 00-23; minute value range: 00-59)	
	OverSpeed	XXXkm/h (speed value range: 30-140)	
		Disable	
	Service	Next Service XXXXX km	
		Service required	
		Service completed	
	Volume	High	
		Medium	
		Low	
Unit	Temperature	°C	
		°F	
	Pressure	Bar	
		psi	
Mileage, APC		km, kW·h/100km	

1

2

3

4

5

6

7















8

Vehicle description

First-level menu	Second-level menu	Third-level menu	Fourth-level menu
Settings	Unit	Mileage, APC	mile, kW·h/100mile
	EPS mode	Drive mode linkage	
		Customized mode	
		Comfort	
		Normal	
		Sport	
	Rear seat reminder	On	
		Off	
	Language*		

Warnings and indicators

Introduction of warnings and indicators

Image	Name	Description
	Left turn signal indicator	Left turn signal is on
	Right turn signal indicator	Right turn signal is on
	High beam indicator	High beam lamp is on
	Rear fog indicator	Rear fog lamp is on
	Low outdoor temperature indicator	Outdoor temperature is lower than 4°C
	Intelligent high beam (IHBC) indicator*	Intelligent high beam headlight is on
		Intelligent high beam headlight is faulty
	Position indicator	Position lamp is on
	Anti-lock braking system (ABS) is faulty indicator	Anti-lock braking system is faulty
	EBD fault indicator	EBD system is faulty
	Brake system fault indicator	Brake liquid level is too low or brake system is faulty
		Brake system is faulty
	Parking brake indicator	Parking brake is enabled
		Auto Hold function is enabled
	Electrical park brake (EPB) system fault indicator	Electrical park brake system is faulty

1

2

3

4

5

6

7

8

Vehicle description



































Image	Name	Description
	Automatic vehicle hold (AVH) indicator	Auto Hold function is enabled
	Automatic vehicle hold (AVH) fault warning indicator	AUTO HOLD function is faulty
	Airbag fault indicator	Airbag system is faulty
	Seat belt unfastened indicator	Front-row seat belt is not fastened. Fasten it please.
	Electronic stability control (ESC) system fault indicator	Electronic stability control system is faulty
	Electronic stability control system (ESC) OFF indicator	Electronic stability control system is off
	Low-voltage battery charging fault indicator	Battery charging is faulty
	Automatic emergency braking (AEB) system fault indicator*	Automatic emergency braking system is faulty
	Automatic emergency braking (AEB) system OFF indicator*	Automatic emergency brake system is off
	Adaptive cruise control (ACC) status indicator*	Adaptive cruise control system is activated
		Adaptive cruise control system is enabled but not activated
	ACC fault indicator*	ACC system is faulty
	Intelligent cruise control (ICC) system status Indicator*	Intelligent cruise control system function is enabled but not activated
		Intelligent cruise control system is activated
		Intelligent cruise control (ICC) system function degrades
		Intelligent cruise control (ICC) system is faulty
	Lane keeping assist (LKA) system status indicator*	Lane keeping assist system is enabled

Image	Name	Description
	Lane keeping assist (LKA) system status indicator*	Lane keeping assist system is faulty
	Lane keeping assist (LKA) system status indicator*	Lane keeping assist system is off
	Electric power steering (EPS) system fault warning indicator	Electric power steering system is faulty
	Tire pressure monitoring system (TPMS) indicator	The tire pressure monitoring system is faulty with abnormal tire pressure or has not learned
	Retarder fault indicator	Retarder system is faulty
	Retarder fault indicator	Retarder system is faulty
	System fault indicator	The vehicle control system is faulty
	Motor and controller overheat indicator	The drive motor and controller are faulty
	Power battery fault indicator	Power battery is faulty
	Charging cable connection indicator	The vehicle is connected to the charging cable
	Power limit indicator	The vehicle has some specific faults and the power is limited
	Ready for operation indicator	The vehicle is ready and can be driven normally
	Low power battery level indicator	Power battery level is too low
	Economic mode indicator	The vehicle is in the economic mode
	Sport mode indicator	The vehicle is in the sport mode
	Long-distance mode indicator	The vehicle is in the long-distance mode
	Low-speed warning off indicator	Low-speed warning function is off

1

2

3

4





5

6

7

8

Vehicle description

Image	Name	Description
	Hill descent control (HDC) system Indicator	HDC system is faulty
	Hill descent control (HDC) system Indicator	HDC system is enabled
	Power battery charging indicator	The power battery is charging or heating
	Blind spot monitoring fault indicator	Blind spot monitoring is faulty



- If the vehicle power supply is placed in the ON gear or the vehicle is started, some indicators will perform self-check and be on for a few seconds before going out. If any fault makes indicators constantly on or light up during driving, pay attention to it and contact Geely Automobile Service for maintenance as soon as possible. Otherwise, severe casualty or property loss may occur.
- The indicator is constantly on after the vehicle is started, or it is on while the vehicle is driving, it means that the vehicle may be faulty seriously. Please contact Geely Automobile Service for maintenance as soon as possible. ◀



Black icons in the table are displayed as white in the instrument cluster display. ◀

Head up display (HUD)*

Heads up display (HUD)

The displaying area of HUD is about 4 m below and ahead of the windshield, and represented by a virtual image. Driver can turn HUD on/off, or adjust the up and down position and brightness of the display.

HUD settings

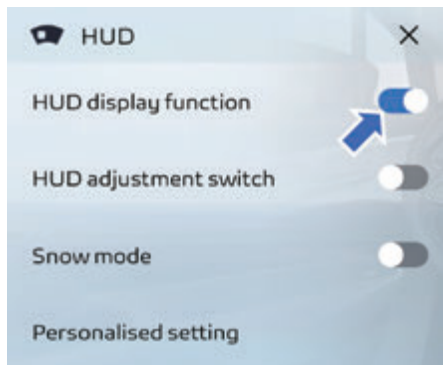

On the multimedia display screen, click Set up → Smart Cabin → HUD to enable/disable the HUD function in this interface.

HUD adjustment switch

The HUD adjustment switch can be turned on or off on the HUD switch interface to set the HUD brightness and position adjustment.

- Height adjustment: push up or down the selection and confirmation button on the right side of the steering wheel.
- Brightness adjustment: press the left or right selection button on the right side of the steering wheel.

After adjustment, press the select and confirm button on the right side of the steering wheel to save the settings and exit.

 The brightness of HUD can be intelligently adjusted according to the ambient light. ◀

Snow mode

Snow mode ON/OFF.

 Snow mode can also be enabled for clear display of HUD when driving in snow. ◀

Personalization settings

Turn on/off the active safety display and Bluetooth phone display.

 The visibility of HUD is affected by the following conditions:

- Polarizing filter or polarized sunglasses may affect the visibility of HUD images, making the image dark or unclear.
- In extreme sunlight, the image part may gradually disappear briefly and then recover, which is normal.
- If light is blocked by foreign objects on the upper trim cover of HUD, the image display may be affected.
- The front windshield is a kind of special glass, go to Geely Automobile Service for replacement.
- Rainstorm or wet road surface may affect the imaging, which is normal. ◀

1

2

3

4

5

6

7

8

Head up display (HUD) image information

2D display mode

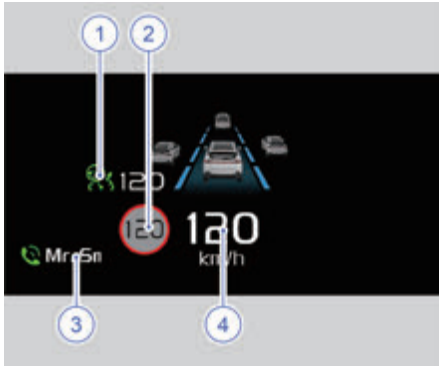

1. Intelligent driving system (ADAS)
2. Road speed limit information
3. Bluetooth call display
4. Vehicle speed

Air conditioner

Front A/C control system

A/C control panel in multimedia display screen



- | | | | |
|-----|--|-----|---|
| 1. | A/C setting button | 11. | Seat heating/ventilation button* |
| 2. | Front windshield defrosting/defogging button | 12. | OFF button |
| 3. | Exterior rearview mirror/rear windshield defrosting and defogging button | 13. | AUTO button |
| 4. | ION button* | 14. | A/C button |
| 5. | Air quality system(AQS) button* | 15. | A/C MAX button |
| 6. | G-clean button* | 16. | Interior/exterior circulation switch button |
| 7. | A/C energy-saving mode button | 17. | Dual zone control button |
| 8. | Air outlet mode face blowing button | 18. | Air volume adjustment button |
| 9. | Air outlet mode foot blowing button | 19. | Front occupant side temperature adjustment button |
| 10. | Air outlet mode window blowing button | 20. | Driver side temperature adjustment button |



In the A/C control panel on the multimedia display, the air outlet mode face blowing button, the air outlet mode foot blowing button and the air outlet mode window blowing button can all be used independently or combined as required. ◀

Description of front A/C control system buttons

1. A/C setting button

Click this button, and the multimedia display will automatically turn to the A/C setting interface.

2. Front windshield defrosting/defogging button

To quickly clear the fog or frost on the front windshield, direct air flow toward the front windshield. For optimal effect, clear all ice and snow from the front windshield before defogging. Turning the air volume adjustment button while defogging will increase or decrease the air volume to accordingly, and the air outlet mode is kept as the defrosting mode.

When the front windshield defrosting/defogging function is enabled, the A/C and external circulation will be automatically turned on. When the current air volume is lower than the 5th gear, the air volume will be automatically adjusted to the 5th gear. Do not turn off A/C and external circulation for maintaining the defrosting/defogging effect.

When the air conditioner is off, operate the front windshield defrosting/defogging button and the air conditioner is activated to execute the front windshield defrosting/defogging function.

3. Exterior rearview mirror/rear windshield defrosting and defogging button

Press this button to turn on/off the exterior rearview mirror/rear windshield

defrosting/defogging function. When the exterior rearview mirror/rear windshield defrosting/defogging function is enabled, the button indicator will be on. Press this button again to turn off the exterior rearview mirror/rear windshield defrosting/defogging function.



Do not use any scraper or sharp tool to clear frost or other substances on the inside of the front/rear windshield. To avoid damage to the rear windshield defogger grill. Repair caused thereby is not covered by warranty. Make sure all objects are at a safe distance from the rear windshield. ◀

4. ION button*

Click this button, and when the button indicator is on, the negative ion generator will be turned on to purify the air in the vehicle.

5. Air quality system(AQS) button*

Click this button, when the button indicator is on, the air circulation mode will be automatically controlled, and the internal/external circulation mode will be automatically switched when the outside air quality is poor.

6. G-clean button*

When the vehicle is started, click this button to select whether to enable/disable the G-clean function.

7. A/C energy-saving mode button

Click the energy-saving mode button of the air conditioner to turn on or off the energy-saving operation mode of the air conditioner.

8. Air outlet mode face blowing button

1

2

3

4

5

6

7

8

- Click the button to select the air outlet mode as the face blowing mode.
9. Air outlet mode foot blowing button
Touch the button to select the air outlet mode as the foot blowing.
 10. Air outlet mode window blowing button
Touch the button to select the air outlet mode as the window blowing.
 11. Seat heating/ventilation button*
Click this button, and the multimedia display screen will automatically jump to the seat heating and ventilation setting interface.
 12. OFF button
When the air conditioner is working, press OFF button and the running of the entire A/C system will stop.
 13. AUTO button
Press this button to enable the automatic mode of the air conditioner. When the automatic mode is enabled, the air conditioning system will enter the automatic control state according to the set temperature.
 14. A/C button
Press this button to turn on the air conditioner, and the A/C button indicator will be on. Press this button again, the button indicator will be off, and the compressor will be turned off.
When the air conditioner is off, press A/C button and the air conditioner is activated.
 15. A/C MAX button
Touch the A/C MAX button, and the set temperature is automatically adjusted to the minimum, and the air volume to the maximum.
 16. Interior/exterior circulation switch button
Press this button to manually switch between external circulation (fresh air) and internal circulation. In the automatic air quality control system (AQS) mode, the internal/external circulation vent status is automatically adjusted according to the outside air quality.
When the air conditioner is off, press the internal/external circulation switch button, and the air conditioner is still off, but the internal/external circulation will be switched.
 17. Dual zone control button
Click the button to enable the dual zone control function. Then, the button icon will be highlighted, and the temperature on the driver's side and the front occupant's side will be adjusted simultaneously. Click the synchronization button again, the button icon will not be highlighted, and the temperature on the driver's side and front occupant's side can be adjusted independently.
 18. Air volume adjustment button
Press this button to adjust the air volume of the air conditioner.
When the air conditioner is turned off, operate the air volume adjustment button, and the air conditioner will be activated for operation.
 19. Front occupant side temperature adjustment button
Adjust the temperature at the front occupant side. Touch \wedge or \vee above and below the temperature value, to set the temperature higher or lower by 0.5° C. The temperature setting range of the air conditioner is 17.5 °C~31.5 °C. When

the temperature setting is higher than 31.5 °C, it is HI. When the temperature is below 17.5 °C, it is LO.

20. Driver side temperature adjustment button

Adjust the temperature on the driver side. Touch \wedge or \vee above and below the temperature value, to set the temperature higher or lower by 0.5° C. The temperature setting range of the air conditioner is 17.5 °C ~31.5 °C. When the temperature setting is higher than 31.5 °C, it is HI. When the temperature is below 17.5 °C, it is LO.

Air vent adjustment

Front air vent

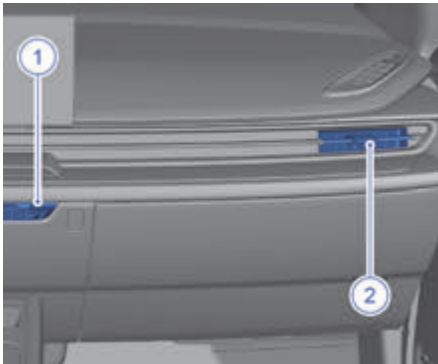

1. Central air vent
2. Side air vent

Rear air vent

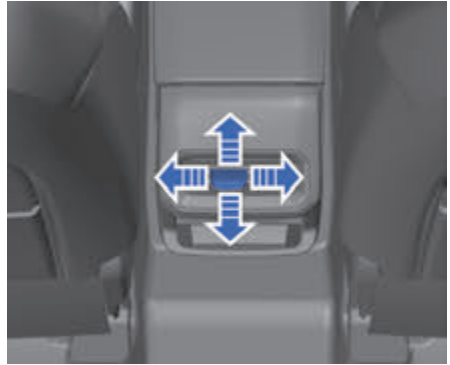

Adjust the airflow direction by changing the direction of the air vent grille up and down, left and right.

Then, turn off the air flow volume by adjusting the blades.

1

2

3

4

5

6

7

8

A/C settings

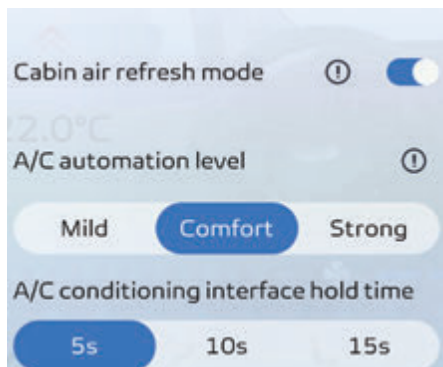
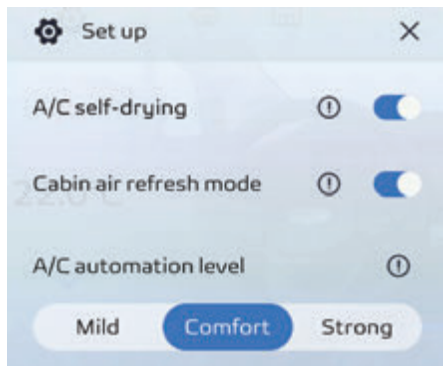

On the multimedia display screen, click Air Conditioner → Set up in turn to enable/disable the functions of air conditioner self-drying, active cabin cleaning, automatic leveling of air conditioner and holding time of air conditioner interface.

A/C self-drying function

After the self drying function of the air conditioner is enabled and the vehicle is locked, and after the conditions are met, the air conditioner will automatically turn on the blower to dry the surface water of the evaporator so as to avoid the peculiar smell

caused by the moisture and mildew of the evaporator.

Active cabin cleaning function

When the cabin cleaning function is turned on, after the vehicle is unlocked and before the doors are opened, the air conditioner will automatically turn on the blower when the conditions are met to blow out the peculiar smell in the vehicle, which realizes the effect of automatic cleaning.

A/C self-leveling function

Except when the set temperature displays LO or HI, press the AUTO button to select soft, comfortable or strong, and the air outlet of the air conditioner will change accordingly.

Holding time of A/C interface

When there is no operation on the air conditioning interface, select 5 seconds, 10 seconds or 15 seconds, and the system will exit the air conditioning interface according to the set time.

Air monitoring system*



1. Air quality system(AQS) button
2. G-clean button

Touch G-clean button, and the air conditioner will automatically turn on the purification function, perform real-time air quality check, and automatically switch the internal and external circulation according to the exhaust, so as to isolate the poor air outside. When AQS is activated, the status icon of AQS will be highlighted, and the AQS is active by default.

Light and wiper

Light control combination switch

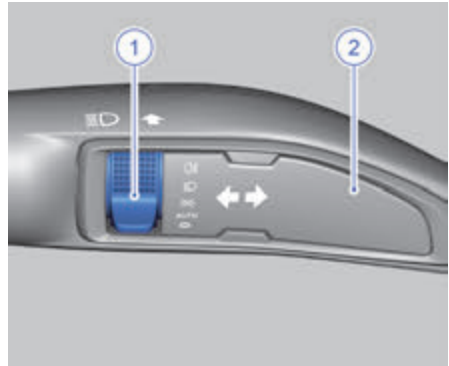

1. Light control switch
2. Light/wiper switch handle

Operation of lighting combination switch

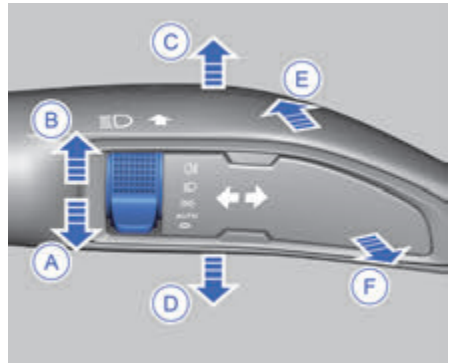

Automatic lighting

After the vehicle is powered on, the light control switch is in the AUTO gear, and the automatic lighting is turned on by default. The automatic lighting system automatically controls the on and off of the headlights according to the external light intensity to achieve automatic control of position lamp and low beam headlights.

1

2

3

4

5



6

7



8

 This system has manual-control-priority function in automatic work mode; the system will exit automatic lamplight mode if there is lamplight signal input. ◀



Position lamp

Push the light control switch to the position  in the direction B, and the position lamp is on. Push the light control switch to the position  in the direction A, and the position lamp is off.

Low beam

Push the light control switch to the position  in the direction B, and the low beam lamp is on. Push the light control switch to the position  or  in the direction A, and the low beam lamp is off.

Rear fog lamp

On the premise that the low beam lamp is on, push the light control switch to the position  in the direction B, and the rear fog lamp is on. Push the light control switch to the position  in the direction A, and the rear fog lamp is off.

Switching between high/low beam

On the premise that the low beam lamp is on, turn the handle to the extreme position in the direction E to turn on the high beam lamp. Push the light switch handle in the direction E again to the limit position, and the high beam lamp is off.

High beam flashing

Turn the handle in the direction F to the limit position, and the high beam lamp flashes. Release the handle, and the high beam lamp will automatically turn off. Repeat the operation to flash the high beam lamp.

Turn signal

Turn the handle in the direction C/D to the limit position, and the right/left turn signal lamp flashes. After turning, the handle will automatically return to its original position, and the turn signal lamp is off.

Lane changing lamp function

Turn the handle in the direction C or D to the middle gear. Release it and the handle will automatically return, and the right/left turn signal lamp will flash.

Headlamps height adjustment



According to the number of occupants and the load of the vehicle, turn the headlamp height adjustment knob up and down to adjust the headlamp beam height.

Daytime driving lamp

After the vehicle is started and the low beam lamp is off, the daytime driving lamp will be on.

When the low beam lamp turns on, the daytime driving lamp automatically is off.

 For the configuration where the daytime driving lamp is integrated into the headlamp, the daytime driving lamp will

be off temporarily when the turn signal lamp is working. ◀

Follow Me Home

Enable Follow Me Home



On the multimedia display screen, click Set up → Vehicle Setting → Lamp in turn. Select any timing in the setting interface of Follow Me Home, and Follow Me Home is enabled.

When the vehicle anti-theft is the disarming state and Follow Me Home is not disabled in the multimedia display screen, turn the light combination switch to the AUTO position, Follow Me Home can be activated automatically after the vehicle is locked.

Disable Follow Me Home

Follow Me Home will be temporarily disabled if any of the following conditions is met:

- Vehicle power supply is not turned off.
- Timeout.
- High beam lamp is on or flashing.

Follow Me Home timing



On the multimedia display screen, click Set up → Vehicle Setting → Lamp. Select the timing in the setting interface of Follow Me Home as required. When Follow Me Home is enabled, the timer is set to the preset timing. Before the timer exceeds, if any door (including trunk door) is opened and all doors are closed, the timer will be reset to the preselected timing time.

Wiper control combination switch

Wiper switch control combination

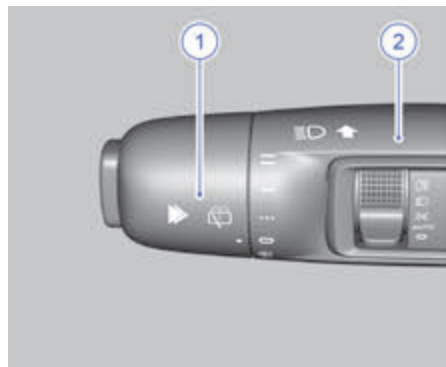

1. Adjusting knob for wipers
2. Light/wiper control handle

1

2

3

4

5

6

7

8



When the windshield is dry, do not use wipers. Otherwise the wipers will scratch the windshield and affect service life of wiper blades.

If there is dust or sand on windshield, use wipers after cleaning the dirt at first. Otherwise the wipers will scratch the windshield and affect service life of wiper blades. ◀

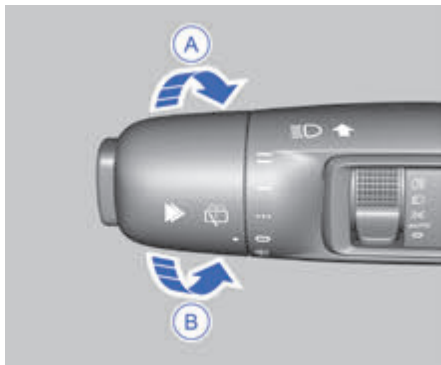
Operations of wiper combination switch



Wiper inching wiping

Turn the adjustment knob to the position  in the direction B for a short pause, and then release the adjustment knob. The adjustment knob will automatically return to the gear position , and the wiper will perform the inching operation once.

Wipers off

Turn the adjustment knob to the  gear position to turn off the wiper.

Wiper intermittent wiping

Turn the adjustment knob to the position  in the direction A, and the wiper will perform intermittent wiping operation.

Automatic wiping of front wipers

Turn the adjustment knob to the position  in the direction A, and the front wiper will

perform automatic wiping operation. The wiping speed is automatically adjusted by the wiper control system as per rainfall.

Low-speed wiping of wipers

Turn the adjustment knob to the low-speed gear position  in the direction A, and the wiper will perform the low-speed wiper operation.

High-speed wiping of wipers

Turn the adjustment knob to the high-speed position  in the direction A, and the wiper will perform the high-speed wiping operation.

Front windshield washing

Turn the adjustment knob to the position  in the direction B and keep it still. When the windshield washer sprays water, the wiper wipes. When the adjustment knob is released, the washer stops spraying water. After cleaning, the wiper remains active for three cycles. After the interval of 5 seconds, the wiper wipes for one cycle.

Wiping of rear wipers

Press and release the tail button of the wiper control handle to select the first gear, and the rear wiper will continuously wipe. When the first gear is selected again, the rear wiper will stop wiping.

Washing of rear windshield

Press the button at the end of the wiper control handle to select the second gear. When the rear windshield washer sprays water, the wiper wipes. After releasing the button at the end of the wiper control handle, the washer stops spraying water, the wiper wipes again several times and then resets, and the rear wiper continuously wipes at the same time.

Wiper linkage after reversing

On the multimedia display screen, click Vehicle Setting → Wiper in sequence, and the wiper linkage function after reversing can be enabled or disabled in this interface. When the function is enabled, the front wiper will wipe, and when reversing, the rear wiper will intermittently wipe in an automatic way.

Interior lighting

Front interior lamps

Type I

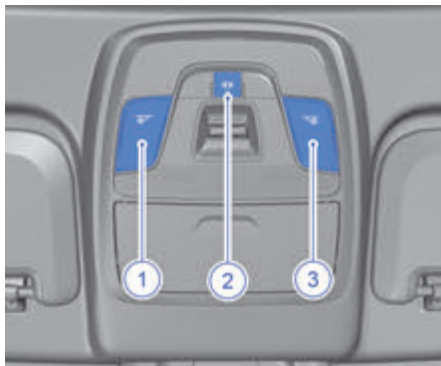

1. Front left interior lamp switch
2. Interior lamp door-control switch
3. Front right interior lamp switch

Click the left or right front interior lamp switch to turn on or off the corresponding front interior lamp separately.

Click the interior lamp door-control switch to enable or disable the interior lamp door-control function.

Type II

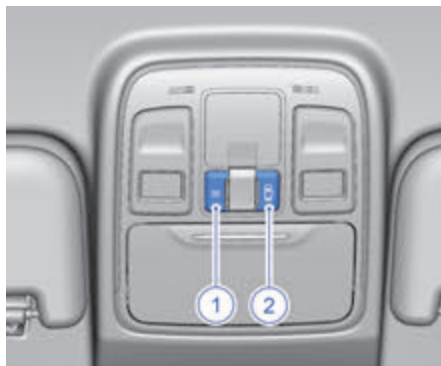

1. Front interior lamp switch
2. Interior lamp door-control switch

Click the front interior lamp switch to turn on or off the front interior lamp.

Click the interior lamp door-control switch to enable or disable the interior lamp door-control function.

i Before enabling the door-control function of interior lamps to turn on the left and right interior lamps, turn off the corresponding lights by clicking the front interior lamp switch. ◀

! Avoid using front interior lamps when driving at night. Bright lights may affect driver's safe driving and cause traffic accidents. ◀

Interior lamp door-control function

After the door-control function is enabled, the interior lamp will automatically turn on or off according to the door status.

The door-control function of interior lamp is enabled by default. If it needs to be disabled, press the door-control switch of

1

2

3

4

5

6

7

8

interior lamp to disable the door-control function of interior lamp.

Ambient lamp*

Ambient lamp settings

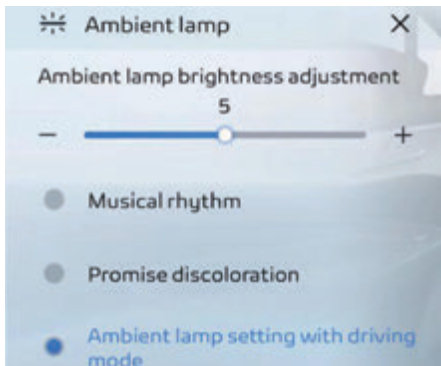

Click the following on the multimedia display screen in sequence: Set up → Smart Cabin → Ambient lamp, and then select Atmosphere Lamp Mode in the interface.

Foot lamp*



The foot lamp is located on the lower guard board of the instrument panel above the driver's and front occupant's feet.

Outdoor lamp

Courtesy lamp*

Approach the vehicle with a valid key, the low beam lamp and position lamp will be on.

Steering wheel

Horn



Press the horn icon area (as shown by the arrow) on the steering wheel, and the horn beeps.

Steering wheel adjustment

 Be sure to not adjust the steering wheel while the vehicle is running; otherwise, personal injury and property damage may be caused. ◀

 After adjusting the steering wheel position, please confirm whether steering wheel is secured properly; otherwise, it will cause personal injury and property damage. ◀

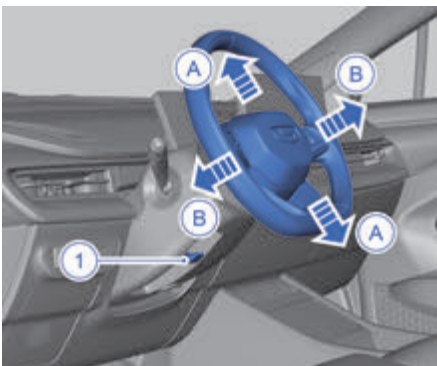

1. Steering wheel locking lever
Follow these steps to adjust the steering wheel to a suitable position:

1. Adjust the appropriate driving position;
2. Turn the steering wheel to the forward straight driving position;
3. Fully release the steering wheel locking lever;
4. Hold the steering wheel with both hands, and adjust the steering wheel to the most appropriate position forward and backward;
5. After adjusting the steering wheel to a proper position, fully fold the steering wheel locking lever to lock steering wheel in the new position.

Steering wheel button

Type I

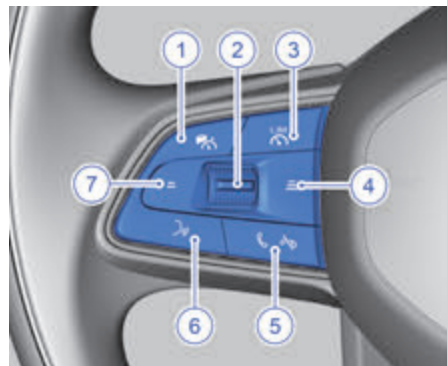

1. Intelligent navigation/adaptive cruise button: press the button to enable or disable the intelligent navigation/adaptive cruise system.
2. Speed adjustment and setting button: in cruise state, it is used for cruise adjustment; in speed limit state, it is used for speed limit adjustment.

Vehicle description

- Push this button upward to return to the original set cruise speed or increase the cruise speed.
 - Push the button downward to set the current vehicle speed to the cruise speed or reduce the cruise speed.
3. Speed limit button: enable the active speed limit function, and set the speed through the speed adjustment and setting button. The speed limits of LIM is 30-160 km/h.
 4. Headway increasing button: increase the following distance of intelligent pilot/adaptive cruise system.
 5. Talk button: answer/hang up a call.
 6. CarPlay button*: CarPlay function is enabled/disabled(reserved).
 7. Headway decreasing button: decrease the following distance of intelligent pilot/adaptive cruise system.

Type II

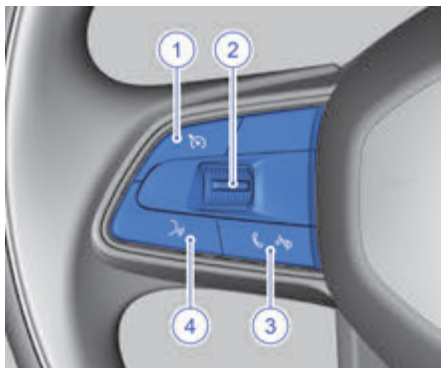

1. Constant speed cruise recovery button: press and release this button to start, stop and exit the constant speed cruise system.
2. Switch for speed adjustment and setting button:

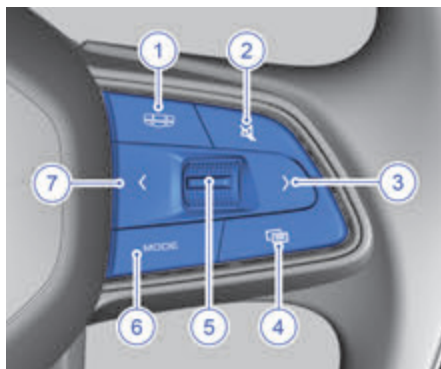

- Push this button upward to increase the cruise speed.
 - Push this button downward to decrease the cruise speed.
 - Press this button to activate the function of the cruise control system.
3. Talk button: press and release this button to answer or hang up a Bluetooth call; press and hold this button to reject an incoming call.
 4. CarPlay button*: CarPlay function is enabled/disabled(reserved).

1. Home button: press and release this button to return to the main multimedia interface.
2. Mute button: press and release this button to turn off mute.
3. Right selection button: press this button to jump to the next valid radio station in the radio state, and play the next file in the multimedia mode.
4. Mode switch button: press and release this button to switch the control of steering wheel keys on multimedia display and combination instrument
5. Volume adjustment and confirmation button: move this button up and down to

adjust the volume, and press this button to pause/confirm.

6. MODE button: press and release this button to switch the sound source.
7. Left selection button: press and release this button to jump to the previous valid radio station in the radio state, and play the previous file in the multimedia mode.

Rearview mirrors

Exterior Rearview Mirror

 Be sure to not adjust the exterior rearview mirrors while the vehicle is running; otherwise, personal injury and property damage may be caused. Be sure to unfold exterior rearview mirrors and adjust them properly before driving. ◀

 When the exterior rearview mirror is frozen, do not operate the adjustment switch of exterior rearview mirror or scrape the ice on the rearview mirror with a sharp tool. Instead, use the heating function of exterior rearview mirror to remove the ice on the surface of exterior rearview mirror. Then adjust the exterior rearview mirror. Do not touch the exterior rearview mirrors during adjustment to avoid personal injury. ◀

Adjustment of exterior rearview mirror



The exterior rearview mirror adjustment switch is on the trim panel of the driver side door.

1. When the vehicle is in the ON or ACC gear, rotate the exterior rearview mirror

1

2

3

4

5

6

7

8

adjustment switch so that the mark — on the exterior rearview mirror adjustment switch points to L (left side) or R (right side) to select the corresponding left and right exterior rearview mirrors;

2. Toggle the exterior rearview mirror adjustment switch back/forth, left/right to adjust the angle of exterior rearview mirror glass;
3. After adjustment, reset the exterior mirror adjustment switch to the initial position (0).

Folding of exterior rearview mirrors

Manual folding of exterior rearview mirrors

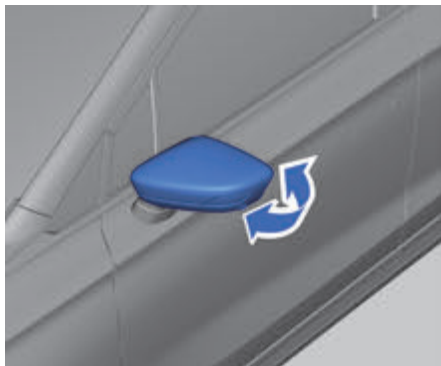

Manually push the exterior rearview mirror inward to fold it.

Manually push the exterior rearview mirror outward to unfold it.

Electrical folding of exterior rearview mirrors*



When the vehicle is in the ON or ACC gear:

1. Rotate the exterior rearview mirror adjustment switch to make the mark — to  the position to fold the exterior rearview mirror.
2. Turn the exterior rearview mirror adjustment switch to other positions to unfold the exterior rearview mirror.

 Frequent folding and unfolding of the exterior rearview mirror will result in temporary failure of the electric folding function. ◀

Auto unfolding of exterior rearview mirrors*

When exterior rearview mirrors are folded, if the vehicle speed is greater than or equal to 15 km/h, exterior rearview mirrors will automatically unfold.

Automatic folding function of exterior rearview mirrors during vehicle locking*

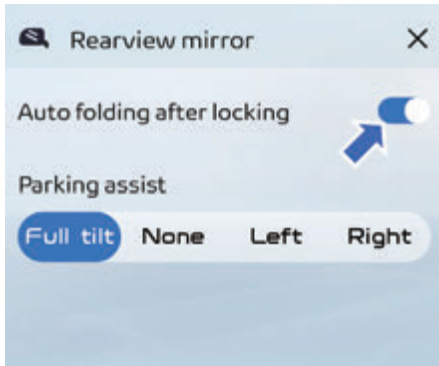

Click on the multimedia display screen in sequence: Set up → Vehicle Settings → Rearview Mirror, open or close automatic folding function of locking exterior rearview mirror in the interface.

When the exterior rearview mirror adjustment switch is in the unfolded gear and the exterior rearview mirror is in the folded state triggered by the locking action of the vehicle, the exterior rearview mirror will automatically unfold after the vehicle is unlocked or the vehicle is started.

When the exterior rearview mirror adjustment switch is at the unfolded gear and the exterior rearview mirror is in the unfolded state, the exterior rearview mirror will automatically fold after the vehicle is locked.

Automatic tilt function of exterior rearview mirrors during vehicle reversing*

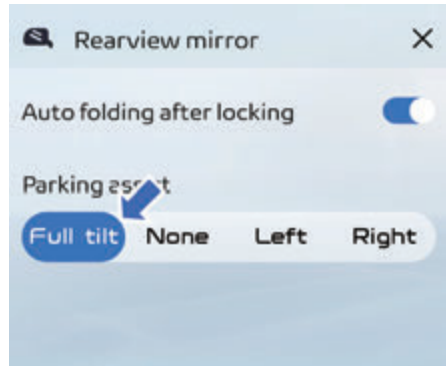

On the multimedia display screen, click Set up → Vehicle Setting → Rearview mirror in sequence, and in this interface, select to set the automatic tilt function of the reverse exterior rearview mirror.

In the multimedia interface, select four modes: Full Tilt, None, Left and Right. The corresponding mode can be selected according to the actual driving situation to improve the safety during reversing.

Electrical heating & defrosting function of exterior rearview mirrors

Press the Exterior Rearview Mirror/Rear Windshield Defrosting and Defogging button  on the front air-conditioning control panel, and the button indicator is on. The heating of exterior rearview mirror and the defrosting of rear windshield are activated simultaneously, and automatically deactivated after a period of operation. The time depends on the ambient temperature. The lower the ambient temperature, the longer the heating time.

1

2

3

4

5

6

7

8

Interior rearview mirror

Adjustment of interior rearview mirrors

Adjust the angle of the interior rearview mirror to the position you want by turning it.

 Do not adjust the interior rearview mirror while the vehicle is running. Otherwise serious personal injury and property loss may occur. ◀

Electronic dimming interior rearview mirrors



After the vehicle is started, the interior rearview mirror senses the intensity of incident light through the light sensor to trigger the electronic dimming function.

If the electronic dimming function is activated, the interior rearview mirror will automatically perform dimming according to the incident light at the rear. When the start switch is turned off or the shift lever is put into reverse gear, the electronic dimming function is automatically disabled.



- The electronic dimming function of interior rearview mirror works only when the incident light at interior rearview mirror is not affected by other objects.
- It is forbidden to paste stickers or install a dashboard camera in front of the interior rearview mirror, so as not to affect its function. ◀



The electronic dimming interior rearview mirror is equipped with sensors. Do not hang anything on the interior rearview mirror or use glass detergent. Otherwise the electronic dimming interior rearview mirror may not work properly. ◀

Window

Power window



- Do not leave children, incapacitated adults or pets in the locked vehicle with windows closed. Personal injury or death may be caused by the temperature being too high to open the doors and windows.
- Do not attempt to test the anti-pinch function with your body; otherwise, it will cause personal injury or death.
- When the window is completely closed, and the top of the glass is less than 4 mm from the window frame, the anti-pinch function may not work. ◀

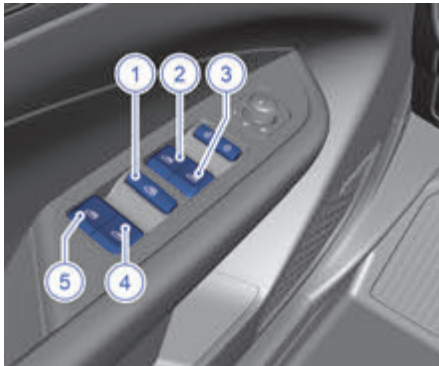

1. Window locking switch
2. Left front window switch
3. Right front window switch
4. Right rear window switch
5. Left rear window switch

Manual operation

Open: press down on the window switch and hold to open the window.

Close: pull up and hold the window switch to close the window.

Automatic operation

Press down or pull up the window switch to the automatic down or up gear, and then release the switch to open or close the window automatically. During automatic window opening or closing:

If the window switch is pressed or pulled up again, the window opening or closing will stop;

The windows also have a remote one-button closing function:

The vehicle power supply is in the OFF position and the windows are open. Press and release the lock button on the smart key, and the window will rise until it is completely closed.

Remote opening/closing of windows

When the vehicle power supply is in the OFF gear and the protective cover of the charging port cover, the trunk door, the front hood and the four doors are closed, press and hold the unlock button on the smart key, and the four windows will open at the same time. Press and release the lock button on the smart key to close the four windows at the same time.

Window locking switch

Press the switch to enable the locking function. The window locking switch indicator is on. Disable the switch operation of the front occupant side window and the rear window. The front occupant side window and the rear window can still be

1

2

3

4

5

6

7

8

raised or lowered through the driver side window switch.

Press the window locking switch again, the window locking switch indicator will be off, and the locking function will be disabled.

Power window over-temperature protection

If power window is operated repeatedly in a short time, the control switch for the power window may fail to protect the motor service life. Wait for a while to resume the power window operation.

 If the waiting time for automatic recovery is long and you need to operate the window immediately, you can power off and restart the vehicle to operate the power window. ◀

Anti-pinch function

During the automatic closing operation, if an object is caught between the glass and the window frame, the window will automatically stop and return to the initial state. If the window is violently impacted, this function may work even if no objects are caught. If the anti-pinch function of power windows does not work properly, adaptive-learning of power windows is required.

Adaptive-learning of anti-pinch power window

If the battery of the vehicle is reconnected or does not work properly after power failure, the power windows will need to re-learn the anti-pinch function.

 Before self-learning, it is necessary to replace the battery or recharge the vehicle battery. ◀

The self-learning steps are as follows:

1. Pull the window switch up to the manual up-shifting position until the window glass has fully risen to the top position, then pull up the window switch again and hold it for more than 2 seconds before releasing it;
2. Press down the window switch to the manual down-shifting position until the window glass fully lowers to the bottom position, then press down the window switch again and hold it for more than 2 seconds before releasing it;
3. Complete the rise and fall of other glasses again to complete self-learning;
4. If the power window does not work properly after the above operations, please go to Geely Service for maintenance.

Delay operation function

When the vehicle power supply button is placed in the OFF position, and if the following three conditions are met, the operation of the window can be maintained through the window switch.

1. The vehicle power is switched to OFF within 60 seconds.
2. Left and right front doors are not opened.
3. The smart key is not operated to unlock/lock the vehicle.

Sunroof*

Panoramic sunroof

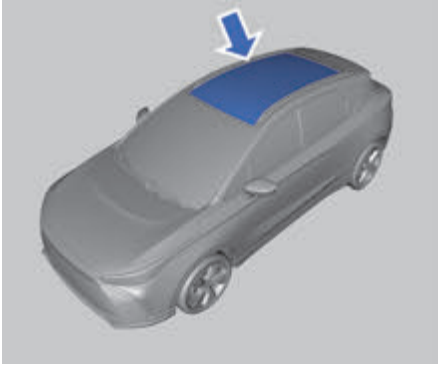

The panoramic sunroof has large glass area, good daylighting, bright interior, and cannot be opened.

Sunroof sunshade



The sunshade switch is on the front interior lamp.

Sunroof sunshade opening/closing

Turn the sunshade switch backward and release it, and the sunshade will slip by inching when it is opened.

Turn the sunshade switch backward and hold it, and the sunshade will automatically open to the fully open position.

Turn the sunshade switch forward and release it, and the sunshade will slip by inching when it is closed.

Turn the sunshade switch forward and hold it, and the sunshade will automatically slide to the fully closed position.

 It is not advisable to squeeze the sunroof sunshade forcibly to prevent the sunshade from falling off, resulting in abnormal noise, difficult operation, etc.

When the vehicle is parked for a long time, it is recommended to close the sunroof sunshade. If possible, it is better to park it in the garage to prevent the vehicle from being exposed to the sun for a long time and damaging the interior. ◀

Sunroof sunshade self-learning

The self-learning steps are as follows:

1. Turn the sunshade switch forward and hold it until the sunshade is fully closed. Release the sunshade switch.
2. Turn the sunshade switch forward again and hold it for 13 seconds. The electric sunshade motor will beep twice. Then, the one key open/close function self-learning of the electric sunshade is completed.

 If the electric sunshade does not work properly after the above operations, contact Geely Service for maintenance.

1

2

3

4

5

6

7

8

Sun visor

Sun visor and makeup mirror

Turn down the sun visor or pull it out of the bracket and turn it towards the door to reduce glare.

Type I



The sun visor is equipped with a makeup mirror, and some models are also equipped with a makeup mirror lamp (some models). Push the cover plate to the right/left to use it.

Type II



There is a makeup mirror in the sunshade, and flip its cover up before using it.

Storage space

Front storage

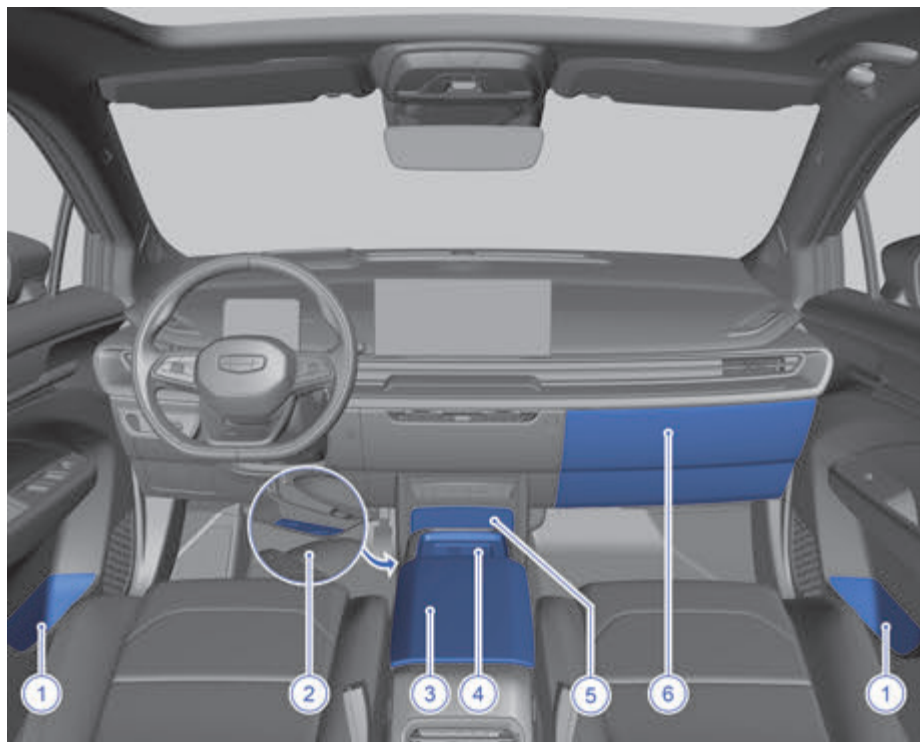

- | | |
|---|----------------------|
| 1. Door storage box | 4. Front storage box |
| 2. Lower storage box of auxiliary console | 5. Front cup holder |
| 3. Front center armrest | 6. Glove box |

1

2

3

4

5

6

7

8

Center armrest opening/closing



A storage box is designed under the center armrest of the front row seats, which can be seen by turning up the center armrest.

 Never open the storage box in the center armrest while the vehicle is driving. ◀

Glove box opening/closing



Press the glove box button to open the glove box. Push the glove box cover forward to close the glove box.

Glasses case

Type I



The glasses case is integrated with the front indoor lighting lamp.

Type II



The glasses case is integrated with the front indoor lighting lamp.

Rear storage

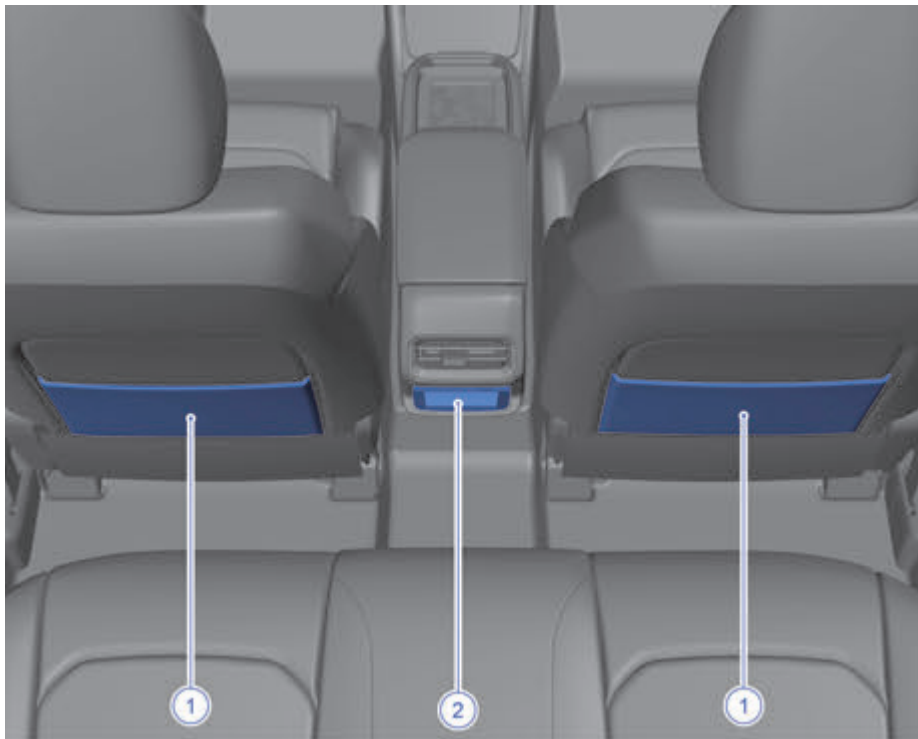

1. Magazine bag

2. Rear auxiliary box of auxiliary dashboard

1

2

3

4

5

6

7

8

Vehicle description

1. The magazine bag is located on the back of front seat and is used to contain small objects like newspaper, maps etc.

 Do not put heavy or sharp objects in the magazine bag to avoid damage to the magazine bag. ◀

2. The storage box at the rear of the auxiliary instrument panel can be used to store smaller items.

Rear center armrest

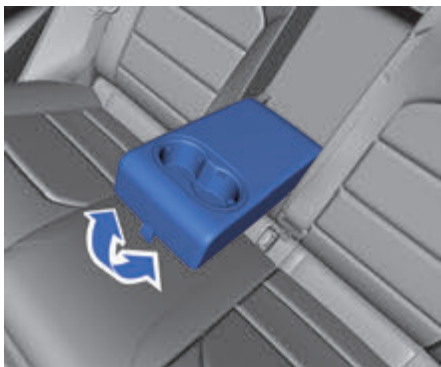

The rear center armrest is in the middle of rear seat backrests. Pull it downward to open and use it. Open the center armrest to use the rear cup holder.

Trunk storage



When the trunk door is opened, the left trunk lamp is on automatically.

 Do not put any pet in the trunk. ◀



- If the weight of loaded goods exceeds the loading capacity of the vehicle, or the weight distribution of the vehicle is uneven after being loaded, the driveability of the vehicle will be affected seriously and the driving safety will be reduced. Luggages in the loading area will move in case of a traffic accident or emergency braking. Try to place objects at lower and forward position; namely, place them as close as possible to rear seat backrest.
- When loading high or large objects, the size of the objects shall not exceed the height of the seat back and the compartment, and the objects must be fixed on the vehicle to ensure driving safety. ◀

In-vehicle power supply

Wired charging

Front charging interface



1. Type-C charging interface
2. USB multimedia interface

Type-C charging interface is used to charge mobile devices.

USB multimedia interface has data transmission function.

Rear charging interface

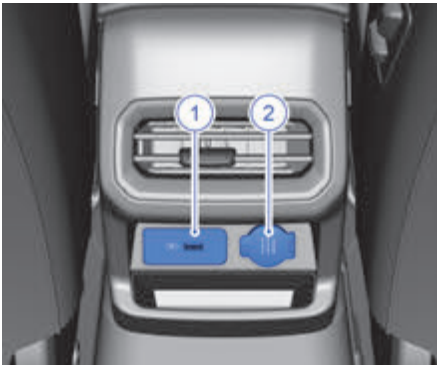

1. USB charging interface
2. Backup power supply

The USB charging interface is used to charge mobile devices.

Backup power supply can be used to connect electrical equipment with a maximum power of 120W.

Wireless charging*

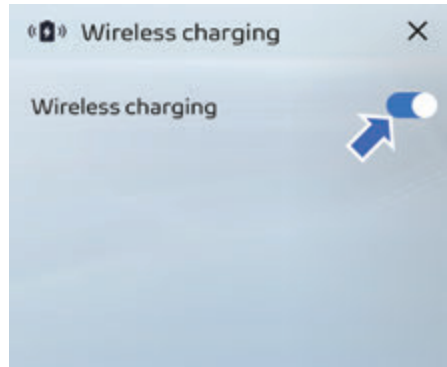

On the multimedia display screen, click Set up → Smart Cabin → Wireless charging to enable/disable the wireless charging function in this interface.



To use the wireless charging board, ensure that the coil in the mobile phone is aligned with the coil in the middle of the charging board. Because the coil position of each mobile phone is different, it may be necessary to adjust the placement position of the mobile phone.

1

2

3

4

5

6

7

8

 Do not place any metal object between the mobile phone and the wireless charging board. If a metal object is stuck between the mobile phone and the wireless charging board, carefully remove the mobile phone and wait for the metal object to cool before removing it. Otherwise, it may cause burns. ◀

 Wireless charging of mobile phones is only applicable to mobile phones certified by the "Qi" protocol, and it may not be possible to charge properly with non-certified mobile phones. ◀

 Do not place the smart key on the wireless charging board, otherwise the keyless start function may not work properly when charging the mobile phone. ◀

Luggage rack

Luggage rack*

The luggage racks are located on both sides above the roof.

 The luggage rack of this vehicle is a non-load-bearing luggage rack, which only plays a decorative role and cannot be affected by external forces. If you need to install a load-bearing luggage rack, please contact Geely Service for installation, and install and use it in strict accordance with the relevant requirements. ◀

Seat belt

Seat belt overview

 All occupants must wear seat belts correctly when the vehicle is driven. In the event of emergency braking or accident, wearing seat belts correctly can reduce the degree of injury to occupants.

- Failure to wear the seat belt or improperly wearing the seat belt may cause serious injury or death!
- No occupant is allowed to sit in area without a seat and seat belt or in a seat with a damaged seat belt.
- Each seat belt can only be used by one person. Do not share a seat belt with more than one person (including children).
- Do not hang the shoulder belt on the neck or pass through the armpit.
- Do not remove, disassemble or reconstruct the seat belt.
- The seat belt in the vehicle is mainly designed according to the body shape of adults, and children should wear appropriate child safety devices.
- Do not use bleach, dyes or chemical solvents to clean the seat belt. ◀

Wear seat belt properly

 When driving, do not tilt the seat back too much, stretch your head or arm out of the window or lean forward too close to the airbag to avoid serious casualties. ◀

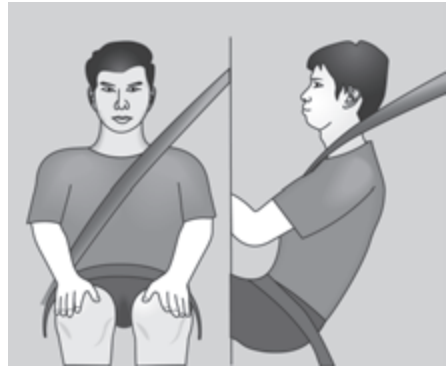

- Seat backrest shall be vertical and the back shall cling to backrest fully.
- The seat belt should be flat.
- The shoulder belt should be fastened across shoulder and chest.
- The crotch strap should be as low and close to the hips as possible.

Fasten the seat belt (for the pregnant)

Before driving a vehicle, pregnant women should consult with a doctor to see if she can drive the vehicle. The method for pregnant women to wear seat belts is basically the same as that for normal use of seat belts, but the following matters should be noted:

1. Lower the waist seat belt as much as possible and place it under the bulging abdomen.
2. The shoulder belt should pass through the shoulder, but should avoid the abdomen so that it is on the chest.

 If the pregnant woman uses the seat belt incorrectly, the seat belt may cause serious casualties to the mother and fetus in case of emergency braking or collision. ◀

1

2

3

4

5

6

7

8

Three-point seat belt

1. Pick up the latch plate, and pull seat belt across body. Do not twist the seat belt. The three-point seat belt may be locked when being pulled across body too fast. If this occurs, unlock the seat belt by shrinking it a little, and then pull the seat belt across your body.

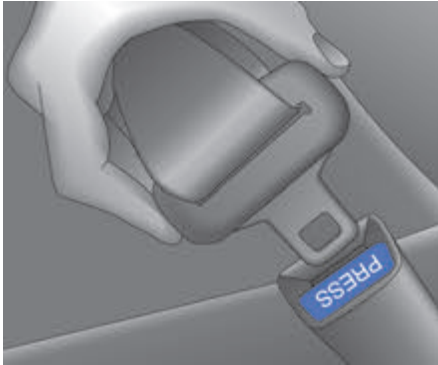

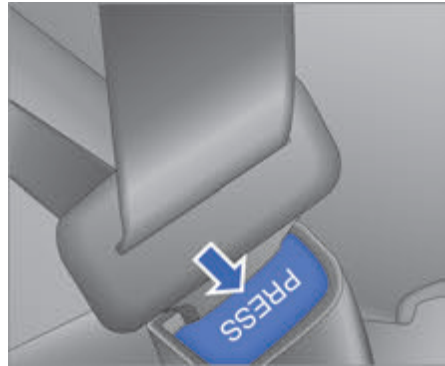

2. Press the latch plate into the lock catch until a “click” is heard. Pull the buckle tongue to ensure it is locked. Confirm position of release button on lock catch for the convenience of unfastening seat belt rapidly when necessary. If equipped with a shoulder belt height adjuster, move it to the appropriate height.
3. The thigh belt can be tightened if the shoulder belt is pulled up.



4. Press the red button on the buckle to unfasten the seat belt. Seat belt should return to unused state.

 Take care to prevent foreign objects such as food scraps, nut shells, buttons, coins, viscous liquid from falling into the seat belt buckle. It may lead to the failure of the reminder function of unfastened seat belt and the locking or unlocking function of the buckle. ◀

 It is forbidden to insert objects other than the vehicle's latch plate into the buckle, otherwise, it may cause the buckle to malfunction. This reduces the protection effect of the seat belt and may result in serious personal injury or death. ◀

 In order to prevent the seat belt from hurting the surrounding area due to too fast retraction or sticking due to too slow retraction, please return the seat belt support to the original position after unfastening the seat belt. ◀

 Before closing the door, make sure that the seat belt is not trapped by the door. Otherwise, the seat belts and doors will be damaged. ◀

Shoulder belt height adjuster

The vehicle is equipped with a shoulder belt height adjuster at the driver's and front occupant's seating positions.

Adjust the shoulder belt height adjuster so that the shoulder belt part of the seat belt is centered on the shoulder. The seat belt shall be far away from the face and neck, and shall not slide under the shoulder. Incorrect adjustment of the shoulder belt height will reduce the effectiveness of the seat belt in the event of a crash.

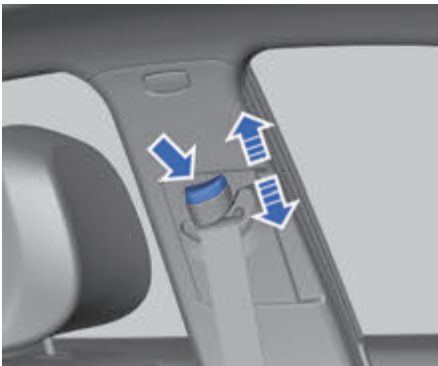

Press the button as shown above and move the height adjuster to the desired position. Move up the adjuster by pressing the button and pushing the slider trim panel upwards. After moving the adjuster to the desired position, release the button and try to move the adjuster down to make sure it is locked in place.

Seat belt pretensioner

The seat belt is equipped with a seat belt pretensioner. In case of vehicle collision, it will tighten the seat belt to ensure the safety of occupants. The pretensioner can only work once. After a collision, it is necessary

to contact the Geely Service to replace the pretensioner, and it may be necessary to replace other parts of the seat belt system.

Seat belt unfastening warning

Driver seat belt unfastening warning

When the driver does not fasten the seat belt, the driver's seat will display red on the instrument cluster display, and the warning lamp for unfastened seat belt will also be on.

Front occupant seat belt unfastening warning

When the front row occupant seat is loaded with occupants and the front row occupants are not wearing seat belts, red will be displayed on the front row occupant seat in the instrument cluster display, and the warning lamp for unfastened seat belts will also be on.

Rear occupant seat belt unfastening warning

When the rear occupant seat is loaded with occupants and the rear occupant does not fasten the seat belt, red will be displayed on the rear occupant seat in the instrument cluster display, and the warning lamp for unfastened seat belt will also be on.

Alarming lamps and buzzer

- When the vehicle power supply is in the ON gear or the vehicle is started, the seat belt alarm will not be triggered whether the seat belt is fastened or not. When the vehicle power supply is in the ON gear or the vehicle is started, if the driver's or front occupant's seat belt is not fastened, the seat belt unfastening warning lamp will be on, and it will not be off until the driver's or front occupant's seat belt is fastened. After the buzzer is

1

2

3

4

5

6

7

8

activated, the corresponding warning lamp will flash synchronously.

- The buzzer is not activated. After the vehicle is started, when the vehicle travels forward at a speed of 25 km/h, if the driver's or front occupant's seat belt is not fastened or the fastened seat belt is unfastened, the buzzer will be activated. The buzzer will stop ringing until the driver's or front occupant's seat belt is fastened or the ringing lasts for more than 120 seconds (the buzzer's beep will not be interrupted by the change of vehicle speed).
- The buzzer is not activated, the vehicle speed decreases from 25 km/h to less than 10 km/h, and the speed is increased to 25 km/h again, and the seat belt unfastened alarm is reactivated.
- The buzzer is activated. When the driver's or front occupant's seat belt is unfastened and the alarm conditions are met, the buzzer will be activated again. The buzzer sounding time will be calculated from the second activation.
- When the vehicle is shifted into the reverse gear, it is shifted into drive gear again. If the driver's seat belt is not fastened, when the vehicle speed is greater than 10 km/h, the buzzer will be activated until the driver wears the seat belt or the buzzer lasts for more than 120 seconds.



Wearing the seat belt correctly can protect the safety of drivers and occupants in case of emergency braking and traffic accidents. Therefore, all occupants should always wear seat belts correctly when driving.

Please pay attention to the warning indicator, otherwise serious personal injury and property loss may be caused. ◀

Airbag

Airbag overview

 Airbag is an integral part of passive safety system which cannot replace seat belt. All occupants in the vehicle must wear seat belt when driving.

Under the influence of the collision's position, angle, degree and property of object collided, airbags may not be deployed in all accidents. The airbag is deployed with great force, so the driver and the front occupant should adjust the seat to have a sufficient safety distance from the front airbag, wear the seat belt correctly and keep the correct sitting posture to avoid serious casualties. ◀

 Ensure there is no barrier blocking the space for airbags to deploy. Do not put any object between the occupant and the airbag. If any barriers are between occupants and airbags, the airbags may be unable to be inflated normally, or the barrier may be squeezed into human body when the airbags are deployed, resulting in severe casualties.

After the airbag is deployed, do not touch it to avoid scalding.

When the airbag is deployed, some gas and dust will be released, which may irritate the skin and eyes. Please go to hospital for treatment if you feel uncomfortable. ◀

 Do not maintain, repair or replace any part of the airbag system without authorization. Otherwise, the system may not work normally, causing serious casualties.

The airbag system can only be used once. If the airbag has been deployed, it needs to be replaced at the Geely Service immediately.



 Due to the considerable speed and strength of airbag deployment, do not seat infants and children or hold them on the front seat with airbag to avoid serious casualties. ◀

Positions of airbags

Frontal airbag

In case of a frontal collision, the frontal airbag can effectively protect the driver and occupant from the frontal impact injury.

When the vehicle suffers from moderate to severe front impact or nearly front impact which reaches the triggering condition of the system, the airbag will be inflated with gas so as to buffer the forward charging speed of driver and front occupant, and prevent the driver and front occupant from hitting on the steering wheel and dashboard directly.

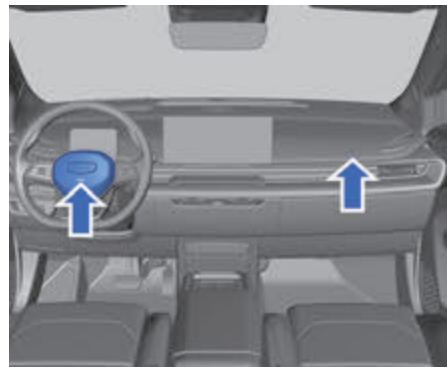

One airbag is mounted in the center of steering wheel and the other in the instrument panel above the glove box, respectively, marked with "AIRBAG".

1

2

3

4

5

6

7

8

Expansion and deflation of airbags are completed within a very short period of time so that airbags will not have protective effects on second follow-up collision. ◀

 Do not press or pound the driver's airbag cover plate vigorously to avoid triggering the deployment of the driver's airbag and causing personal injury.

Do not place objects or pets in front of the instrument panel or glove box and on the steering wheel equipped with an airbag. They will hinder the deployment of the airbag or cause serious casualties due to the large injection force when the airbag is deployed. Do not add or modify, disassemble, knock or open any front airbag component or circuit, otherwise the airbag may suddenly inflate or the system cannot be used, causing serious personal injury or death. ◀

 During the use of the vehicle, do not sit on the side of the seat or lean against the instrument panel, because any person standing against or very close to the airbag may be seriously injured or killed when the airbag inflates. The occupants must keep at least 25 cm away from the airbags. ◀

 When the following conditions occur, contact the Geely Service immediately:

- After the front airbag is deployed.
- The front part of the vehicle was hit, but it did not cause the front airbags to deploy.
- The front airbag cover is cracked, scratched or damaged in other forms. ◀

Side airbag*

The side airbag provides further protection for the driver and front occupant, based on the safety protection provided by seat belts. In case of a moderate or severe side impact, the side airbag can reduce personal injury by inflating and working with the seat belts simultaneously.

Side airbags can mainly reduce chest injuries for driver or front occupant.

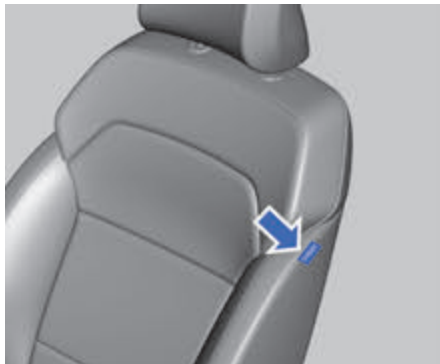

Side airbags are mounted in the backrests of the driver seat and front occupant seat, where they are marked with "AIRBAG".

 Due to the considerable speed and strength of the side airbag when it is deployed, it is prohibited to put your head and hands outside the window or close to the deployed area of the side airbag when the vehicle is driving, otherwise serious casualties may occur to occupants. ◀

 It is forbidden to install seat cover on the seats equipped with side airbags. Otherwise, it may affect the deployment of the side airbag. ◀

☐ When the following conditions occur, contact the Geely Service immediately:

- Side airbags have been deployed.
- The door is impacted, though the side airbag isn't triggered to deploy.
- When the seat cover at the side airbag assembly is damaged, scratched or otherwise damaged. ◀

☐ The following operations are prohibited to affect the normal operation of the side airbag without asking the personnel of Geely Service:

- Install electronic devices such as mobile two-way radio communication devices.
- Refit the occupant side structures. ◀

Side airbag curtain*

The side airbag curtain provides further protection for the driver, front occupant and rear outboard occupants, based on the safety protection provided by seat belts. In case of a moderate or severe side impact, the side airbag curtain can reduce personal injury by inflating and working with the seat belts simultaneously. The side airbag curtain can mainly reduce the head injuries of the driver, front occupant and rear outboard occupants.

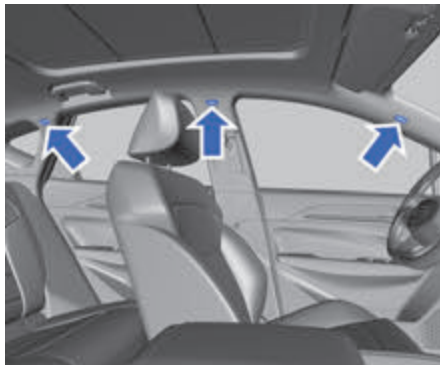

Side airbag curtains are mounted above the left/right doors, marked with "AIRBAG" on it.

⚠ Because the side airbag curtain has a considerable speed and strength when it is deployed, it is prohibited to put your head and hands outside the window or close to the area where the side airbag curtain is deployed when the vehicle is driving, otherwise serious casualties may occur. ◀

⚠ Do not install any decorative parts around the side airbag curtain, such as windshield, door glass, side pillar, roof side, or stick microphone or any other equipment inside the roof and on the auxiliary handles. When the side airbag curtain is deployed, these objects will be thrown out under the strong deployment force of the side airbag curtain, resulting in personal injuries or affecting the normal operation of the side airbag curtain. ◀

☐ When the following conditions occur, contact the Geely Service immediately:

- The side airbag curtains have been deployed.

- The door is impacted, though the side airbag isn't triggered to deploy.
- When the front pillar, rear pillar and roof side member decoration or ceiling fitted with the side airbag curtains have been scratched, cracked or damaged in other forms. ◀

▶ Before consulting the personnel of Geely Service, do not make any of the following changes that may affect the normal operation of side airbag curtains:

- Install electronic devices such as mobile two-way radio communication devices.
- Refit suspension system.
- Repair at or near the bracket. ◀

Deployment of airbag

Deployment of front airbag

The front airbag deploys when the vehicle is in a moderate to severe frontal collision at a speed of 25 km/h or above.

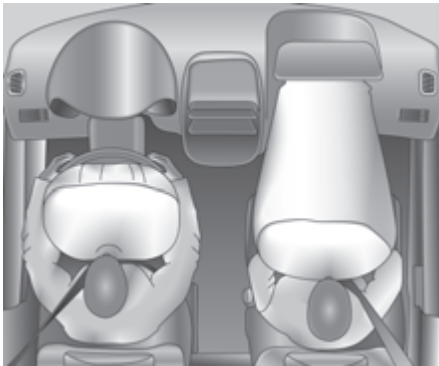

In the event of a collision, whether the airbag works depends on the collision object, the collision direction and the speed of vehicle deceleration caused by the collision. In case of severe frontal collision, the front airbag will deploy.

Deployment of side airbags and side airbag curtain*

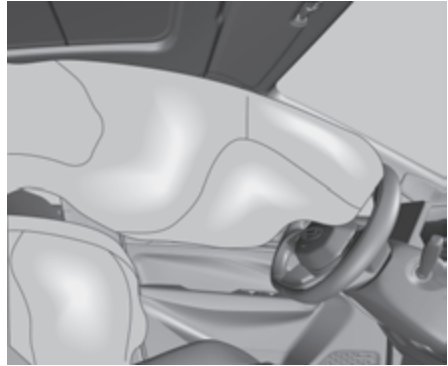

In case of moderate to severe side impact of the vehicle and the designed value is reached, the front side airbag and side airbag curtain (if equipped) can be deployed.

In case of side collision, the deployment of side airbag and side airbag curtain can reduce the risk of upper body and pelvis injury.

Cases in which front airbags may not be deployed

- Vehicle not started.
- When the collision occurs between the vehicle and deformable objects, such as trees.
- When the vehicle collides against low objects like steps etc. in the process of running.
- When the vehicle falls down to a trench or pit suddenly.
- In case of crash (underrun crash) against the rear of truck.
- Rollover.
- Side collision, rear collision and slight head-on collision.

- Airbag system has faults.
- Other special cases.

Cases in which side airbag and side airbag curtain may not be deployed *

- Frontal collision or nearly frontal collision.
- Rear collision.
- Rollover.
- Minor side collision.
- The airbag system has faults.
- Other special cases.

1

2

3

4

5

6

7

8

Child restraint system

Selection of child safety device

Information on the suitability of child safety seats on individual seats when child safety seats are secured with seat belts:

Group	Child weight	Front occupant seat	Rear outboard occupant seat	Rear middle occupant seat
0	<10KG	X	U	X
0+	<13 KG	X	U	X
I	9-18 KG	UF	U	X
II	15-25 KG	UF	U	X
III	22-36 KG	UF	U	X

Note: the meanings of the keywords entered in the table above are: U = Generic child restraint system applicable for the mass group certification; X = child restraint system with seat position not applicable for the mass group.

Information on the availability of child safety seats on vehicle seats, on condition that the child safety seats are secured with an ISOFIX child restraint system:

Child weight group	Category by size	Front occupant seat	Rear outboard occupant seat	Rear middle occupant seat
Group0: < 10KG	E	X	IL	X
Group0+:<13KG	C	X	IL	X
	D	X	IL	X
	E	X	IL	X
Group I:9-18KG	A	X	IUF	X
	B	X	IUF	X
	B1	X	IUF	X
	C	X	IL	X
	D	X	IL	X
Group II:15-25KG	-	X	IUF	X
Group III:22-36KG	-	X	IUF	X

For child restraint systems not classified according to ISO/XX dimensions (A-G), and for the applicable mass group, the vehicle manufacturer shall describe the ISOFIX child restraint system specific to the vehicle recommended for each seating position.

Note: The meanings of the keywords entered in the table above are: IUF = Frontal generic ISOFIX child restraint system applicable for the mass group certification; IL = special ISOFIX child restraint system applicable for the list. These restraint systems may be used for special vehicle types 475, restricted types or semi-generic types. X = ISOFIX position is not applicable for the ISOFIX child restraint system of that mass group and/or that size level.

A – ISO/F3: Full height forward toddler CRS

B – ISO/F2: Reduced height forward toddler CRS

B1–ISO/F2x: Reduced height forward toddler CRS

C – ISO/R3: Full size backward toddler CRS

D – ISO/R2: Reduced size backward toddler CRS

E – ISO/R1: Backward toddler CRS

F – ISO/L1: Left lateral position CRS (load bearing folding bed)

G – ISO/L2: Right side position CRS (CarryCot)

 Make sure to stay away from the head restraints before installing all child restraint systems. ◀

Use of child restraint system

Infants and older children

Infants

All seat belt system and airbag system of vehicle are not designed for protecting infants or younger children. Infants or younger children shall be always protected with corresponding child protective devices.



- If the shoulder belt twines around neck of a child, the child will be severely injured and even killed when the seat belt is tightened gradually. Do not leave children in vehicle alone and do not allow them play with child restraints.
- Be sure not to carry an infant or child in the arms when sitting in the driving vehicle. In the event of a crash, infants and young children cannot be held due to the impact of the crash, and they should be fixed in appropriate child restraint systems.
- The necks of infants and young children are not fully developed, and their heads are heavier than other parts of the body. In order to reduce the risk of neck and head injuries in a crash, infants and young children need comprehensive supports. ◀

Older children

Older children who are beyond the range of child safety seats shall wear seat belts.

The instructions attached to child safety seats states the weight and height limits for the child sitting in it. Children who meet the

following applicable conditions shall use seat belts together with the child safety seat:

- Try to sit on seat as back as possible. Children should not bend their knees at the edge of the seat.
- Buckle the seat belt, and do not put the shoulder belt on children's shoulders.
- The seat belt shall not be worn down and close to the buttocks of children.
- The seat belt cannot be worn correctly during driving.

Older children should wear the seat belt correctly. It is prohibited for the seat belt to cross the child's face or neck, and the seat belt should be close to the child's hips. In case of a crash, the seat belt can provide additional restraint.

Be sure not to wear the seat belt on the abdomen, otherwise serious injury will be caused in the event of a crash.

In the event of a crash, children who do not fasten their seat belts may bump into others or be thrown out of the vehicle, causing serious injury or death.



It is forbidden for two children to share a seat belt, otherwise the seat belt will not be able to disperse the impact force correctly, which will cause serious casualties in the event of a crash. ◀



When a child wears a seat belt, do not let it press behind the child. Otherwise, serious casualties may be caused in the event of a crash. The seat belt should be over the shoulder and across the chest. ◀

Description of the child restraint system

It is generally recommended to use the reverse child safety seat for infants and young children aged 3 – 4 years. For children who are not suitable for a reverse child safety seat due to their large size, the forward child safety seat can be used. For children whose body size is too large to fit in the forward facing child safety seat, use the auxiliary soft seat cushion to fasten the seat belt.

Installation of child restraint system

It is safer for children and infants to be properly secured in the child restraint system in the rear seating position.



When fixing the child restraint system on the rear seat, please carefully read the instructions of the child restraint system to ensure that it is suitable for the vehicle and installed correctly. ◀

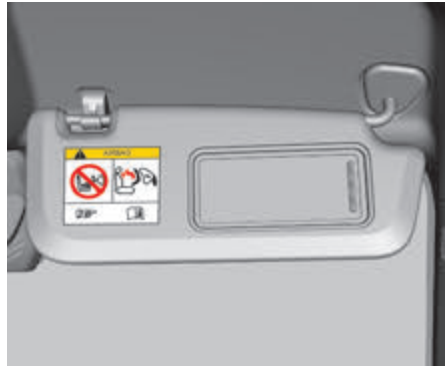

Warning labels are pasted on the front and back of the front occupant's sunshade to remind that the vehicle is equipped with a front airbag and that the related precautions shall be observed.



Do not use any backward child restraint system at a seat that is under frontal airbag protection (in activated state)! It is forbidden to put a backward child restraint system on a front seat. Infants who cling to or are too close to the air bag will be seriously injured or killed when the air bag inflates. ◀

Installation of ISOFIX child restraints



1

2

3

4

5

6

7

8

The special fixing interface specified in ISO is at the gap between the seat cushion and the seat back of two rear seats. Use the fixed interface to install the child restraint system with standard ISO specification on the rear seat. It is not necessary to fix the child restraint system with a seat belt at this time. Please follow the manufacturer's instructions when installing and using child restraint systems, otherwise the protection effect may be affected.

 It is necessary to confirm with the child restraint manufacturer whether the child restraint can be used in this vehicle type. ◀

Install a child safety seat that requires a top tension strap according to the following procedures:

1. Lower the headrest to the lowest position;

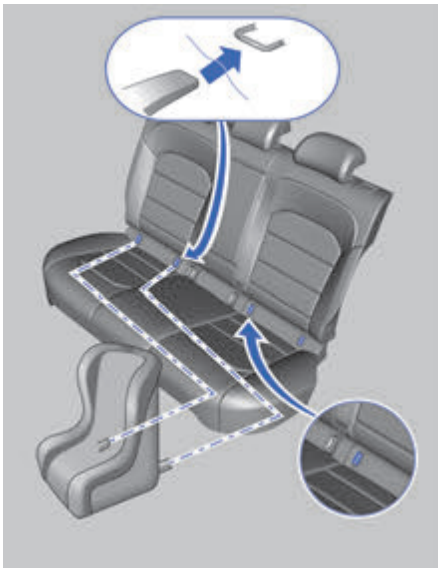

2. Confirm the position of ISOFIX fixed interface;
3. Align the ISOFIX interface of the child restraint system with the corresponding ISOFIX fixed interface behind the seat, and then insert it;
4. Check whether the latch is locked correctly;

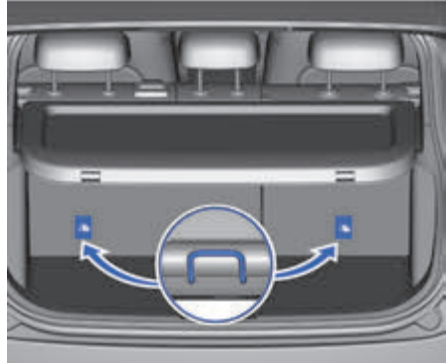

5. Latch the latch on the retaining connector.

 Make sure that the top tension strap is firmly fastened, and push and pull the child restraint system in different directions to check whether it is fixed. It must be installed according to the instructions provided by the manufacturer. ◀

 If the child restraint system is not installed to the ISOFIX fixed interface in the correct way, the child restraint system may not be used normally, causing serious casualties to children. When mounting a child restraint, be sure to strictly follow the restraint manufacturer's instructions.

Child restraint anchorages are only designed to carry loads imposed by properly installed child restraints. Under no

circumstances shall they be used for seat belts, harnesses or other objects and devices to be fixed on the vehicle.

Always mount child restraints when the vehicle is stationary. When the ISOFIX child restraint system is correctly fixed to the ISOFIX fixed interface, there will be a "click" sound. ◀

1

2

3

4

5

6

7

8

Driving

Driving instructions

Under the following conditions, pay special attention to lower parts of the vehicle to avoid scratches on the vehicle chassis.

- When driving on a road with poor conditions.
- When passing road kerb.
- When running on steep slopes.



Take special care when driving with full load. ◀

New vehicle running-in



The running-in of new vehicle is mainly to improve the surface quality and the friction and wear state of moving parts, so as to extend service life and reduce power consumption. During the running-in period of the new vehicle, the following requirements should be met:

- When starting and driving, avoid pressing the accelerator pedal to the bottom.
- In the running-in period, the vehicle should run on flat roads. Driving on a muddy road or sand road should be avoided.
- Avoid idling the drive motor.
- Avoid rapid acceleration. ◀

Driving in winter

Winter tire

It is recommended to use winter tires if you often drive the vehicle on roads with ice or snow. Although all-season tires can provide excellent comprehensive performance on most surfaces, they may be unable to

provide expected friction force or same performance level as winter tires when running on roads covered with ice or snow.

Usually, using winter tires is to increase friction force on road surface covered by ice or snow. If the vehicle with winter tires run on a dry road, the vehicle traction will drop, road noise will increase and tire tread pattern's service life will be shortened. After replacing winter tires, pay attention to the changes in vehicle handling and braking.

Please consult with Geely Service for details about supply and selection of suitable winter tires. If you choose to use winter tires:

- You shall use tires of same brand and same tread pattern on all four wheels' positions.
- Only radial tires of same size, loading range and rated speed as original tires can be used.
- If you choose winter tires with lower rated speed, be sure not to drive at the speed exceeding maximum rated speed of the tires.

Tire chains



Tire chains are not included in the equipment of this vehicle. The following information is for reference only.



1

2

3

4

5

6

7

8

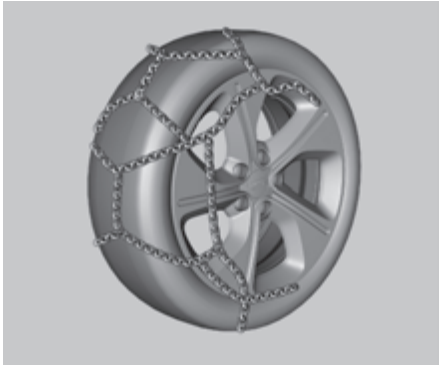

Please determine whether you need to add tire chains according to the actual road conditions.

When tire chains are used, try not to fully load the vehicle. Besides, drive carefully at a low speed. Otherwise, it is possible to damage the vehicle and affect the drivability of the vehicle.

When installing tire chains, it is necessary to select tire chains corresponding to tire size of the vehicle, and please install tire chains strictly in accordance with instructions of manufacturer.



Do not use tire chains on dry roads. ◀

Economic driving

Vehicle endurance mileage and power battery capacity are affected by driving habits, storage conditions, charging methods, power battery temperature, etc. Good operation and driving style can improve the driving range of the vehicle.



When driving a vehicle, make sure to drive safely, observe traffic laws and do not hamper others and public traffic order. ◀

- 1. Stable starting and accelerating**
Power consumption is high when starting and accelerating. Try to avoid depressing the accelerator pedal for starting or accelerating when driving the vehicle. Stable starting and acceleration are helpful to save power saving.
- 2. Avoid unnecessary braking**
Keep the following distance from the preceding vehicle, and try to avoid frequent braking. Slow down in advance when encountering a red light, and let the vehicle slide in gear to avoid sudden braking.
- 3. Keep low wind resistance**
Opening windows at high speeds will significantly increase the vehicle's wind resistance, resulting in increased power consumption. Please close the windows when the vehicle speed is higher than 80 km/h.
- 4. Maintain correct tire pressure**
Check the tire pressure regularly. If the tire pressure is too low, the rolling resistance of the tire will increase, resulting in increased power consumption.
- 5. Reasonable use of air conditioners**
Both refrigeration and heating air conditioning will accelerate the power consumption of the power battery. Please use the air conditioner when necessary. Open windows at a low speed. The internal circulation mode will save more energy with when you use air conditioner.
- 6. Reduce vehicle load**
Each additional kilogram of weight may increase the power consumption, and

the unnecessary luggage on the vehicle shall be cleaned regularly.

7. Plan the running route properly
Optimize the route and try to avoid traffic jam. This will not only save time but also reduce power consumption.
8. Do not change the size of the tire at will
The use of larger or wider tires will result in increased power consumption.
9. Driving mode selection
The extreme endurance mode is used when the vehicle is driving, which can reduce the vehicle power consumption and increase the endurance mileage. On the contrary, selecting sport mode will increase the power consumption of the vehicle and shorten the driving range.

Driving through water

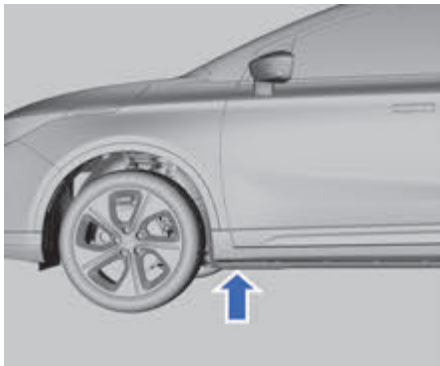

To prevent vehicle being damaged when driving through water (e.g. flooded roads), it is necessary to pay attention to the following precautions:

1. It is necessary to confirm the water depth before driving through water. The water level should not go above the edge of the border girder.

2. Drive at a low speed (less than 30 km/h), otherwise waves may form in front of the vehicle, damage the motor controller and other components, and make the vehicle unable to drive.
3. Do not park or reverse in water under any conditions.



When driving on water, mud and other roads, the braking effect may be affected and the braking distance may be extended, which may cause accidents!

Avoid sudden or emergency braking operations immediately after driving through water.

When the vehicle runs on the road with water, the brakes must be cleaned and dried as soon as possible by intermittent braking. Brake when traffic conditions permit, to dry and clean the brakes and avoid traffic accidents. ◀



Height of wave made by the vehicle from the opposite direction may exceed the allowed water level of this vehicle.

Pits, wallows or stone may be hidden in water. They will make driving through water more difficult.

Do not drive through salt water. Salt causes vehicle rust. Immediately use fresh water to wash all metal parts in contact with salt water.

After driving through water, it is recommended to go to the Geely Service to conduct a comprehensive inspection of the vehicle, investigate hidden dangers, and ensure driving safety. ◀

1

2

3

4

5

6

7

8

Vehicle parking

- Park the vehicle on a flat, solid and safe road that does not affect the traffic of other vehicles.
- When parking, first depress the brake pedal and then use the electric parking brake until the vehicle stops slowly and stably, and then place the vehicle in the P gear.



Do not leave children or people with limited mobility in the vehicle. They may release the parking brake and shift paddle, causing the vehicle to move and causing casualties. ◀

Vehicle start

Starting procedures

Enter the vehicle with a valid smart key, depress the brake pedal and start the vehicle. If the smart key is not in the vehicle or subject to some interference, the combination instrument display will display the prompt that the key is not in the vehicle.



As long as all starting conditions are met, the vehicle will start when the brake pedal is pressed. After the vehicle is started, the READY lamp of the combination instrument is on, and the vehicle enters the drivable state. ◀



When mobile phones, laptops and other electronic devices are placed together with the smart key, the keyless start function may fail. When this function fails, keep the smart key at a certain distance from the electronic devices. Place the smart key in the storage box below the rear of the auxiliary instrument panel. ◀

Standby start function

If the vehicle is in a strong signal interference area, the battery of the smart key is low, or the keyless start function fails, if you try to start the vehicle and depress the brake pedal, the combination instrument may have a text prompt, and the vehicle cannot be started through the sensorless start program at this time.

Please start the engine as per the following steps:

1. Place the vehicle in the parking position (P).



2. Put the smart key in the glove box below the rear of the auxiliary instrument panel.
3. Depress the brake pedal.

Gearshift operation

Gear information

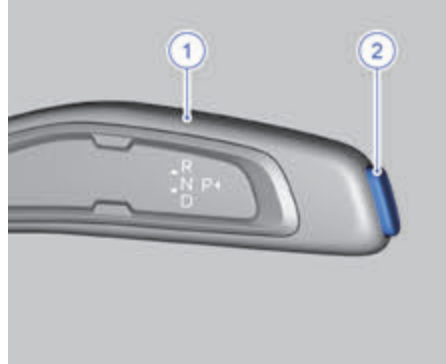

1. Shift lever
2. P-gear button

According to the currently selected gear, push the shift paddle up/down to switch among the following gears: reverse gear (R), neutral gear (N) and drive gear (D). Press the P gear button to switch to the parking gear (P).

Shift

Parking

When parking for a long time or on a ramp: after stopping the vehicle completely, pull up the electric parking brake (EPB) switch to perform parking brake, and then switch to the parking gear (P). Then the vehicle will be locked. Short time parking: the vehicle can be placed in neutral (N). In order to stop the vehicle reliably, pull up the electric parking brake (EPB) switch at the same time for parking brake.

 Stop the vehicle for a short time. Do not put the vehicle in the D or R gear and always depress the brake pedal, otherwise the service life of the reducer will

1

2

3

4

5

6

7

8

be affected. In any case, do not shift the vehicle into the parking gear (P) when moving, otherwise serious mechanical damage will be caused and the vehicle will lose control. ◀

Forward

Start the vehicle in the parking gear (P) or neutral gear (N), depress the brake pedal, confirm that the parking brake has been released, place the vehicle in the drive gear (D), release the brake pedal, and gently depress the accelerator pedal.

▶ Engage the gear first and then depress the accelerator pedal. It is not allowed to engage the gear while depressing the accelerator pedal, or depress the accelerator pedal first and then engage the gear. ◀

Reversing

When the vehicle is stationary, depress the brake pedal, confirm that the parking brake has been released, place the vehicle in the reverse gear (R), release the brake pedal, and gently depress the accelerator pedal.

Driving mode

Driving mode

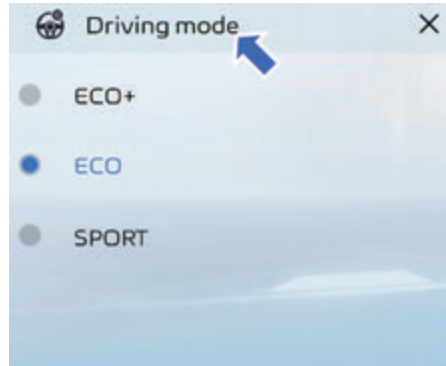

On the multimedia display screen, click Set up → Vehicle Setting → Driving mode in turn. In this interface, you can switch between economy mode, comfort mode and sport mode.

Economy mode

In the ECO+ mode, all forward gears will automatically shift up in advance and down behind, which can effectively reduce the engine speed and achieve better fuel economy.

ECO mode

In the ECO mode, the economy and sportiness of the vehicle are relatively balanced.

SPORT mode

The SPORT mode is used when the vehicle needs good power performance. In this mode, the control system will make the vehicle have better power performance, and optimize the acceleration performance by rapidly increasing the output power. Then, the power consumption will increase and the endurance mileage will decrease.

Intelligent driving system

Intelligent driving system introduction

Front camera*

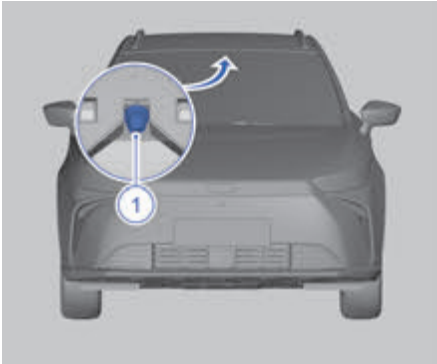

1. Front camera

The intelligent driving system recognizes the lane boundary and detects the target through the front camera.

 In daily use, keep the front camera clean, and the view of the front camera cannot be blocked by pollutants (such as rain, snow, fog, moisture, frost, leaves, bird droppings, etc.), or strong light interference, otherwise the performance of the intelligent driving system will be affected.

- Under severe weather conditions such as rainstorm, snowstorm and dense fog, the recognition ability of the front camera will be affected, which may lead to the decline of the system performance.
- If a system failure occurs in the front camera, the instrument cluster display will prompt in text. Please go to Geely Service for maintenance.

- In order to protect the electronic components, the system function will be temporarily unavailable when the front camera is at extremely high temperature. The instrument cluster display will prompt in text. When the temperature drops sufficiently, the front camera unit will automatically restart and the system function will return to normal.
- If the field of vision of the front camera is blocked to enter a dark environment or is interfered by strong light, the instrument cluster display will display a text prompt.
- Do not modify the front camera. When the front camera is subject to strong vibration and slight impact, the calibration will be affected and may need to be recalibrated. ◀

 Blindness of front camera is a normal reaction of front camera under special environments. Without blocking the view of front camera, the driver may avoid dark environment and direct sunlight, and then the system will recover itself. If it cannot be recovered, please go to Geely Service for maintenance. ◀

 When the whole vehicle is powered on, the intelligent driving system needs to be initialized, and it cannot work normally within 10 seconds. ◀

Cruise control system (CC)

With the cruise control system, maintain the speed at any speed between 30-160 km/h without always pressing the accelerator pedal.

1

2

3

4

5

6

7

8

 Do not use the cruise control system on winding, congested or slippery roads, or traffic accidents may occur. ◀

Function selection



In the combination instrument display, select the cruise control system via the menu switch button on the left side of steering wheel. After selection, the cruise control system will be on standby, and the indicator of cruise control system (CC) will be on in white.

Steering wheel control

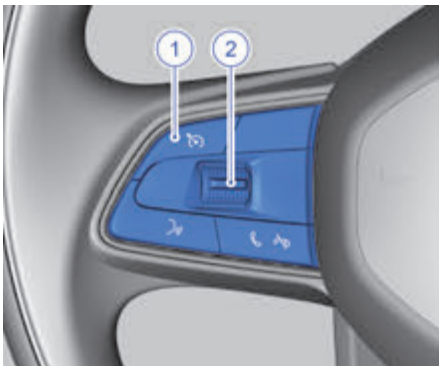

The cruise control button is on the left side of the steering wheel.

1. Cruise control resuming button: resuming cruise or canceling cruise control related functions at the last exiting speed.
2. Switch for speed adjustment and setting button:
 - Push the button up
Push and release: cruise speed +1 km/h.
Push and hold: cruise speed +5 km/h.
 - Push the button down
Push and release: cruise speed -1 km/h.
Push and hold: cruise speed -5 km/h.
 - Press the button
CC function is activated.

 If the cruise control system is selected on the current instrument cluster display screen, accidentally touching the button to enter the cruise state may frighten the driver and cause the vehicle to lose control. ◀

Setting speed

When the cruise control is enabled, push up/down the speed adjustment and setting button to adjust to the required cruise speed, and press this button to set the current speed as the cruise speed.

Restore the set speed

If the cruise control is already set at the required speed, then depress the brake pedal. This cancels the cruise control. To restore to preset vehicle speed, when the vehicle speed is 30km/h or higher, press the cruise control resume button to activate it.

The system controls according to the pre-saved set speed.

Acceleration in cruise control

The acceleration can be realized through either of the two methods:

- Depress the accelerator pedal to increase speed.
- When the cruise control is enabled, push up and hold the vehicle speed adjustment and setting button, and the speed will continue to increase at 5 km/h until the vehicle accelerates to the desired speed or to the maximum set speed of 160 km/h, then release. To slightly accelerate, push the button up. One short up-push and the vehicle speed will increase by 1km/h. One long up-push and the vehicle speed will increase by 5km/h.

Deceleration in cruise control

If the cruise control system is enabled,

- Push down and hold the speed adjustment and setting button, and the speed will decrease constantly at 5 km/h until the vehicle decelerates to the required speed or reaches the minimum set speed of 30 km/h, and then release it.
- To slightly decelerate, push the button down. One short down-push and the vehicle speed will decrease by 1km/h. One long down-push and the vehicle speed will decrease by 5km/h.

Overtaking when using cruise control

Increase vehicle speed with accelerator pedal. Vehicle speed will decrease to preset

cruise control speed when the foot leaves accelerator pedal.

Use of cruise control at ramp

The performance of the cruise control system at the ramp depends on the vehicle speed, load and the gradient of the ramp. It is necessary to depress and hold accelerator pedal to maintain vehicle speed when vehicle is climbing up the steep slope. When going downhill, brake or lower to a low gear to maintain the speed. Cruise control will be turned off when brake is applied.

Ending cruise control

The following methods can be used to end cruise control:

- Depress the brake pedal to exit the cruise control system.
- Press and release the cruise control recovery button to exit the cruise control system.
- Press and release twice or press and hold the cruise control recovery button to close the cruise control system.

Clearing vehicle speed memory

When the cruise control or vehicle power supply is turned off, the cruise control set speed memory will be cleared.

Automatic speed limit control system (LIM)

With the automatic speed limit control system (LIM), the driving speed will not exceed the preset speed limit.



Be sure to turn off the automatic speed limit control system after use to

1

2

3

4

5

6

7

8

avoid accidental adjustment of vehicle speed.

- Although the vehicle features automatic speed limit control system, the driver must control the speed according to the situation. Do not press deeply on the accelerator pedal if not necessary.
- It is extremely dangerous to use the automatic speed limit control system in bad weather conditions, which may cause serious casualties when driving on roads with water, ice and snow or leaves. Therefore, the automatic speed limit control system can only be used when both road conditions and weather conditions permit. ◀

Function selection



In the combination instrument display, select the automatic speed limit control system via the menu switch button on the left side of steering wheel. After selection, the system will be on standby, and the indicator of automatic speed limit control system (LIM) will be on in white.

Steering wheel control



The automatic speed limit control button is on the left side of steering wheel, and the setting range of speed limit is 30~160 km/h.

1. Automatic speed limit control recovery or exit button: the last exit speed restores the automatic speed limit control or exits the relevant functions of the automatic speed limit control system.
2. Switch for speed adjustment and setting button:
 - Push the button up
Push and release: cruise speed +1 km/h.
Push and hold: cruise speed +5km/h.
 - Push the button down
Push and release: cruise speed -1 km/h.
Push and hold: cruise speed -5km/h.
 - Press the button
LIM function is activated.

Set speed limit

When the automatic speed limit control is enabled, push up or down the vehicle speed adjustment and setting button to adjust the

required speed limit. Press the button to set the current speed as the speed limit.



Resume speed limit

Deeply press the accelerator pedal during driving, and the automatic speed limit control enters the driver's control state, and the indicator of automatic speed limit control system is on in yellow. But the speed limit is still memorized. When the accelerator pedal is released, the automatic speed limit control resumes, and the indicator of automatic speed limit control system (LIM) is on in green.

Use of automatic speed limit control at ramp

When the vehicle runs downhill, the automatic speed limit control system cannot limit the vehicle speed, and the vehicle will accelerate under its own gravity. At the time, the vehicle speed should be reduced immediately by pressing the brake pedal.

End of automatic speed limit control

- Press the  button, the status indicator of the automatic speed limit control system (LIM) will change from green to white, and the automatic speed limit control will be in standby mode.
- Press the  button when the automatic speed limit control is in the standby state, and the automatic speed limit control will enter the off state.

Clearing vehicle speed memory

When the automatic speed limit control or vehicle power supply is turned off, the

speed memory set by the automatic speed limit control will be cleared.

Adaptive cruise control system (ACC)*

The adaptive cruise control system (ACC) can control the vehicle speed based on the set speed and the inter-vehicle interval in the range of 0~150 km/h.

ACC mainly provides driving assistance for the driver on highways or elevated roads with good road conditions. The driver should keep control of the vehicle at all times.

ACC uses a medium-range radar to detect the vehicle ahead, and maintain the inter-vehicle interval set by the driver through automatic speed adjustment. The driver can control the vehicle at any time according to driving conditions.



ACC will start self-test when the vehicle is powered on, and the system functions are unavailable at this stage. ◀



- ACC is only an auxiliary system, not a warning and collision avoidance system in case of emergency, and cannot replace the driver to drive. The driver must always keep control of the vehicle and bear full driving responsibility for vehicle control. The driver needs to drive in accordance with laws and regulations.
- ACC does not work on vehicles or objects crossing the carriageway.
- The change of vehicle posture due to excessive load in the luggage area and other reasons will degrade or disable the ACC target recognition performance.

1

2

3

4

5

6

7

8

- When suddenly accelerating and approaching the vehicle ahead at high speed (an obvious speed difference with the vehicle ahead), the driver should brake in time.
 - When driving on a steep downslope, it may be difficult for this function to keep a proper distance from the vehicle ahead. Under such circumstances, be especially careful and be ready to brake at any time. Do not use ACC under heavy load.
 - ACC cannot identify tricycles, vehicles carrying irregular shaped goods or vehicles with irregular shapes.
 - ACC system does not recognize stationary or slowly moving vehicles stably and cannot recognize oncoming vehicles.
 - If ACC is activated when the vehicle is stationary, the system will recognize the static obstacle ahead as vehicle and keep still so as to ensure the safe starting of vehicle and avoid the collision with the stationary target due to unexpected starting. Static targets include but are not limited to speed bumps, trees, people, railings, etc.
 - When ACC works, if the driver applies the accelerator pedal, the vehicle will be taken over by the driver, and respond to the driver's acceleration desire. ACC control function will not work.
 - When entering/exiting a curve, the target selection may be delayed or disturbed. ACC may have unexpected braking or late braking.
 - In some cases (the speed of preceding vehicle is too low relative to your own vehicle, and the preceding vehicle jumps into the lane closely, etc.), ACC does not have enough time to reduce the relative speed. In this case, the driver must respond appropriately.
 - If the preceding vehicle suddenly brakes, ACC may fail to respond timely or react too slowly. In this case, the driver will not receive the takeover request. Active braking is required.
 - At a sharp turn, e.g. a serpentine road, ACC cannot detect the preceding vehicle normally due to the visual field limit of front camera, which may lead to the acceleration of ACC vehicle. The driver is required to respond appropriately based on actual conditions.
 - If the distance between the ACC vehicle and the adjacent lane is too small (or the vehicle on the adjacent lane is too close to the lane of ACC vehicle), ACC may react to the vehicle and brake. ◀
-  In following situations, the driver must be especially alert:
- When ACC is activated and confirmed to start with the vehicle stationary, if there are pedestrians, children, animals, two-wheeled vehicles, tricycles or obstacles ahead, ACC cannot detect and identify them, and there is a serious collision risk. The driver must confirm the area ahead of vehicle is safe before activating ACC to control the vehicle to start.
 - In case that the vehicle speed is high, if the left turn signal lamp is turned on when overtaking from the left, ACC will automatically accelerate the vehicle and shorten the distance to the preceding

vehicle. If the vehicle enters the overtaking lane and there is no vehicle ahead, ACC will automatically accelerate to the set cruise speed.

- ACC cannot detect the items loaded or accessories mounted on the target vehicle that protrude from its side, rear end or roof. If the preceding vehicle has the above-mentioned special load or equipment, ACC must be turned off when overtaking such vehicles.
- Towing a trailer will reduce the dynamics of ACC.
- After the system requires the driver to take over the vehicle, if the vehicle continues to move, the driver must apply the brake pedal to brake.
- Structural modification of vehicle, such as lowering the chassis height or changing the front license plate mounting board, may affect ACC. ◀

Function selection

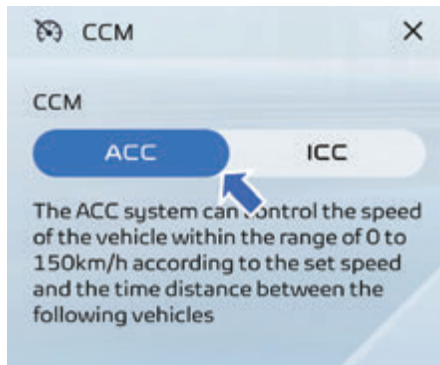

The driver can click Set up → Auxiliary Driving → CCM on the multimedia display screen, and select to enable or disable the adaptive cruise function in this interface.



ACC can be selected through the function menu switch button on the left side of the steering wheel in the instrument cluster display screen. When ACC is selected, it will enter the standby mode, and the ACC status indicator will be on in white.

Steering wheel control

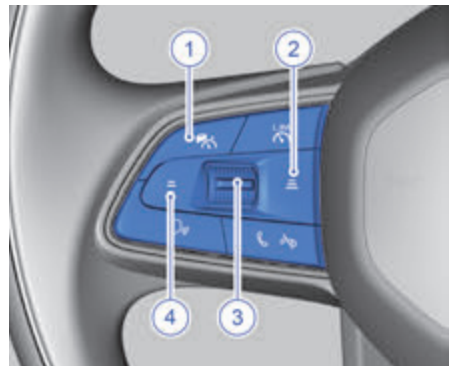

ACC button is on the left side of steering wheel.

1. Adaptive cruise button: press and release this button to start, stop and exit the ACC system.
2. Inter-vehicle interval increasing button
Press and release this button to increase the following distance of ACC system.

3. Speed adjustment and setting button

- Push the button up
Push and release: cruise speed +1 km/h.
Push and hold: cruise speed +5km/h.
- Push the button down
Push and release: cruise speed -1 km/h.
Push and hold: cruise speed -5km/h.
- Press the button
ACC function is activated.

4. Inter-vehicle interval decreasing button

Press and release this button to decrease the following distance of ACC system.



Activate the ACC system, the following conditions must be met:

- Press ACC switch button to exit the ACC system.
- The gear is in the drive gear (D).
- The indicator of the instrument cluster is ready for operation.
- The four doors, trunk and front compartment hood are all closed.
- The vehicle is in motion, and the brake pedal is not applied.
- No fault on brake disc.
- The front camera has no problems such as high temperature, dirt or failure.
- ESC function ON status.
- EPB is released.
- The driver fastens the seat belt. ◀

Speed activation and setting

1. When the vehicle is stationary, activate and set the vehicle speed as follows:

- Select to enable ACC. The ACC indicator on instrument cluster display is on in white.
 - Press the brake pedal or activate the AUTO HOLD function.
 - Press the ACC button or the speed adjustment and setting button to activate ACC, and the ACC status indicator on the display screen of the instrument cluster is green.
 - When the brake pedal is released, ACC system can continue to keep the vehicle stationary.
 - The driver is required to press the ACC button again or depress the accelerator pedal to make ACC control the vehicle to start.
 - The ACC system controls the vehicle according to the set cruise speed.
- ### 2. When the vehicle is in motion, activate and set the vehicle speed as follows:
- Select to enable ACC. The ACC indicator on instrument cluster display is on in white.
 - Press the ACC or speed adjustment and setting button to activate ACC. When the cruise speed is set at 30 km/h, the ACC status indicator on the display of the instrument cluster will be on in green. When the self driving speed is below 30 km/h, the cruise set speed is 30 km/h. If the self driving speed is within 30~150 km/h, the cruise set speed is the current self driving speed.
 - The ACC system controls the vehicle according to the set cruise speed.

- Push the speed adjustment and setting button to set the required cruise speed.

During cruising, as the relative vehicle speed varies, the instrument cluster will display different distance states away from the preceding vehicle to remind the driver.



In the active safety interface, the distance to the preceding vehicle is displayed on instrument cluster interface in real time. The size of the preceding vehicle's image 1 will change with the distance. If the preceding vehicle's image 1 is the target followed by the ACC system, the preceding vehicle's image 1 is blue. If the distance between the vehicle and the preceding vehicle is too close, the preceding vehicle's image 1 is yellow. When the distance between the two vehicles is too close and the driver's active control is required, the preceding vehicle's image 1 is red. If the driver is pressing the accelerator pedal to control the vehicle, the preceding vehicle's image 1 is gray.

If the ACC system is not activated, the ACC status indicator 2 is in white .

If ACC is activated, the ACC status indicator 2 is green. .

If ACC fails, the ACC status indicator 2 will be red .

If the ACC system is not activated, the set vehicle speed 3 is white.

If the ACC system is activated, the set vehicle speed 3 is green.

In addition, if ACC is not activated during this journey, the set speed will not be displayed after the function menu switch button on the left side of the steering wheel is pressed and the function is selected for the first time.



When the ACC system is not activated, if no vehicle ahead, the preceding vehicle 1 will not be displayed. If a target vehicle appears ahead, the preceding vehicle 1 is in gray.

When the ACC system is activated, if no vehicle ahead, the preceding vehicle 1 will not be displayed; When a target vehicle appears ahead and it is followed, the preceding vehicle 1 is in blue; When the vehicle is close to the preceding vehicle, the preceding vehicle 1 is in yellow; When the distance between the two vehicles is too close and the driver's active control is required, the preceding vehicle 1 is in red.

Inter-vehicle interval 2 is the inter-vehicle interval selected by the driver.

1

2

3

4

5

6

7

8

 When the automatic identification speed limit is activated, it may happen that the cruise speed does not change with the speed limit, such as the speed limit value is lower than the threshold value or the difference between the speed limit value and the current target speed value is greater than the threshold value; Meanwhile, due to the influence of light and the position of road signs, speed limit misidentification or missing identification may occur. The driver must not rely on the integration system to determine the appropriate cruise speed, but liable to select the appropriate cruise speed according to the actual road conditions. ◀

 At the speed limit integration, the system will accelerate/decelerate as per the new set value. The driver should keep observing the surrounding environment, and can interrupt the speed limit integration at any time by pressing the accelerator pedal or operating the speed adjustment and setting button. ◀

Set inter-vehicle time distance

 It is the driver's responsibility to choose a safe inter-vehicle interval. ◀

The driver can adjust the inter-vehicle interval of ACC following, based on current road environment. Inter-vehicle interval refers to the time required for the vehicle to travel to the current position of preceding vehicle at the current speed, i. e. the inter-vehicle distance divided by the vehicle speed.

The driver can decrease/increase the interval to the preceding vehicle by pressing the adjustment button of inter-vehicle interval. The inter-vehicle interval has three

gear levels: near, medium and far. Every time the vehicle is started, the default inter-vehicle interval of the ACC system is far.

Different options for inter-vehicle interval are displayed on instrument cluster display.



When the inter-vehicle interval is far.



When the inter-vehicle interval is medium.



When the inter-vehicle interval is near, HUD displays different inter-vehicle intervals via different distance cells.

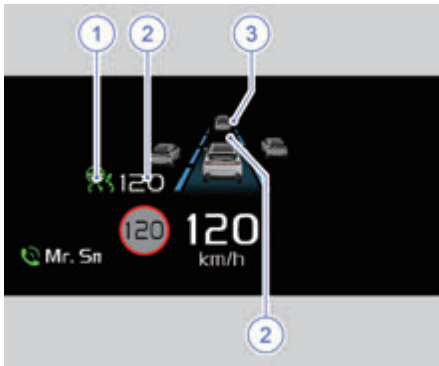

When ACC detects a vehicle ahead, the ACC status indicator will be displayed in the area 1 shown in the figure.

The area 2 in the figure shows the set speed of the ACC system.

The area 3 in the figure shows the vehicle pattern.

The number of cells at the area 4 in the figure shows the set inter-vehicle interval between the vehicle and the preceding vehicle.



In any case, the driver must keep sufficient braking distance from the

preceding vehicle, and be aware of relevant requirements of local highway traffic regulations on the minimum distance or the shortest time. It is the driver's responsibility to abide by the law. ◀

Use the ACC speed control

Acceleration when using ACC system

The acceleration can be realized through either of the two methods:

- Depress the accelerator pedal for active acceleration. In case of active acceleration, the driver takes control of vehicle, and the instrument cluster shows the active vehicle acceleration. After the driver releases the accelerator pedal, the ACC system continues to control the vehicle to cruise.
- If the cruise control system is already enabled, to slightly accelerate, push the speed adjustment and setting button. Push up and release once, the vehicle speed will increase by 1 km/h; For a long push, the vehicle speed will keep increasing at 5 km/h until the button is released. The set speed maximum is 150 km/h.

Overtaking assist mode

In cruise mode, when following the preceding vehicle and turning on the left turn signal lamp, the ACC accelerates/ decelerates the vehicle before it reaches the overtaking lane to assist the driver overtake or change the lane, until the vehicle finishes changing the lane or turns off the left turn signal lamp.

To enable the overtaking assist mode, the following conditions must be met at least:

- There must be a target vehicle ahead.

1

2

3

4

5

6

7

8

- The current vehicle speed exceeds 60 km/h.
- The current lane is dotted.
- The set speed should be high enough for a safe overtaking.
- Turn on the left turn signal lamp.

In the overtaking assist mode, unexpected acceleration may occur in the following situations, which requires special awareness of the driver. Therefore, at the overtaking assist mode, the driver should prepare for sudden change of conditions and control the vehicle in time.

- The vehicle is approaching the turning exit, and the exit direction is the same as that of usual overtaking.
- Before the vehicle passes through and enters the overtaking lane, the speed of preceding vehicle decreases.
- The speed of vehicle in the overtaking lane decreases.

At the overtaking assist mode, unexpected deceleration may occur in the following situations, which requires special awareness of the driver. Therefore, at the overtaking assist mode, the driver should prepare for sudden change of conditions and control the vehicle in time.

- The speed of vehicle in the overtaking lane is lower than your vehicle speed.
- The longitudinal distance between the vehicle in the overtaking lane and your own vehicle is close.
- The vehicle in the overtaking lane is large with long body, and parallel to your own vehicle.



At overtaking assist mode, the driver needs to control the lane change on their own. ◀



Please note that this function can be enabled in more situations besides overtaking. E. g., when the left turn signal indicator is turned on to change lanes or enter another road, the vehicle will briefly accelerate. ◀

Start-stop mode

In the cruise following mode, if the preceding vehicle brakes and stops gradually, your own vehicle will follow the preceding vehicle to stop gradually, and keep a safe distance from it.

- Within 3 seconds after stopping, if the preceding vehicle resumes traveling, the cruise will resume automatically.
- When it's more than 3 s after stopping, if the preceding vehicle resumes, the driver needs to apply the accelerator pedal or press the intelligent driving button to resume cruising.
- In ACC start-stop mode, the longest time to keep the vehicle stationary is 3 minutes. After 3 minutes, EPB is activated, and the ACC system exits.
- In ACC start-stop mode, if the driver actively exits the ACC, the vehicle will not start automatically. If the accelerator pedal is pressed at this time, the vehicle starts, and the driver needs to take control of the vehicle and drive safely.



After stopping, the ACC system can still control the vehicle to move, which may result in uncontrolled vehicle movement. If the vehicle moves

uncontrolled, traffic accident may occur and result in serious injury or death. ◀

 The ACC system will have unexpected acceleration in the following situations. Please be highly alert and take active braking:

- When ACC system follows another moving vehicle and the target changes from a moving vehicle to a stationary vehicle, ACC will ignore the stationary vehicle and continue cruising at the speed set by the driver.
- At an intersection, when following the preceding vehicle to turn at low speed, the following target disappears due to the turning of preceding vehicle, so the ACC will accelerate based on the set speed. ◀

Deceleration when using ACC system

If the cruise control system is already enabled, to slightly decelerate, push the speed adjustment and setting button. Push down and release once, the vehicle speed will decrease by 1 km/h. For a long push, the vehicle speed will keep decreasing at 5 km/h until the button is released. The minimum set speed is 30 km/h.

Restore the set speed

If the driver has set the ACC to the required speed, and depresses the brake pedal or presses the ACC button, then the ACC will be deactivated, and the set speed will be saved, and the set speed will continue to be displayed on the instrument cluster display. To activate the ACC system and cruise as per the last set speed, press the intelligent driving button for activation.

End ACC

The following methods can deactivate ACC:

- Depress the brake pedal to exit ACC.
- Press the adaptive cruise button to exit the ACC system.

The adaptive cruise control is dependent on the operation of other systems, such as the electronic stability control system (ESC). If any of these systems stop working, ACC will be automatically deactivated.

In case of automatic deactivation, a sound signal is given and the instrument cluster display shows a text message. The driver must intervene to match the speed of and the distance to the preceding vehicle.

If the front camera has a system failure, in low light, directly under strong light, blocked by objects, or under alternating light conditions, the ACC may be affected and cannot be used.

Possible reasons for disabling ACC (including but not limited to):

- Any door, front compartment hood or trunk is opened.
- Driver's seat belt is unfastened.
- The wheels losses traction.
- The brake system performance is degraded or faulty.
- Parking brake is applied.
- The front camera is covered by wet snow or heavy rain.

Detection problems

The detection range of the front camera is limited. In some cases, the front camera may fail to detect vehicles or delay the detection of vehicles.

1

2

3

4

5

6

7

8

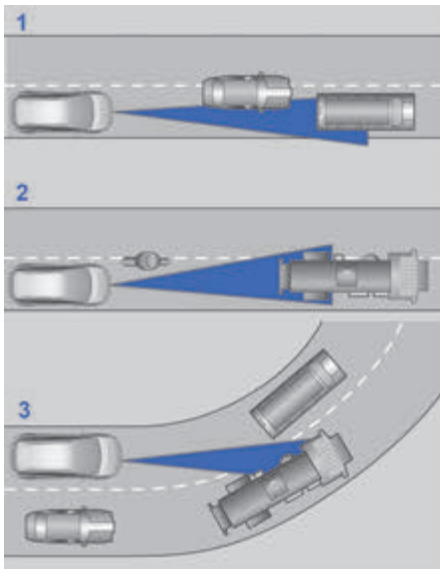

Detection problems may occur in the following situations:

1. Vehicles move slowly along the driver's lane. The system can only detect the vehicle that has fully entered the driver's lane.
2. When the preceding vehicle is a large truck, the time of detecting the vehicle may be delayed.
3. When the driver enters or exits a curve on the road, detection problems related to the preceding vehicle may occur.
4. When the whole vehicle is powered on, the front camera needs initialization, and the preceding vehicle cannot be accurately detected within 10 seconds.

Under such circumstances, the driver should keep alert. Take emergency measures and temporarily shut down the ACC if necessary.

Intelligent cruise control system (ICC) *

The intelligent cruise control (ICC) system can simultaneously perform vehicle cruise control and direction assist control in 0~130 km/h. The system can control the self driving speed according to the set speed and the following inter-vehicle interval, and control the self driving in the middle of the lane according to the lane lines on the left and right sides or follow the preceding vehicle for tracking control.

The ICC system mainly provides driving assistance for the driver on highways or elevated roads with good road conditions. The driver should keep control of the vehicle at all times.

The ICC system uses medium-range radar to detect the vehicle ahead, and maintain the inter-vehicle interval set by the driver through automatic speed adjustment, and maintains the vehicles in the lane through the direction assist control.

The premise that the ICC system provides lane keeping control is that the system recognizes the lane lines on both sides at the same time. If the lane lines are lost or unclear, the ICC system will downgrade to cruise control only and will not perform direction assistance control. When the system recognizes the lane lines on both sides again, it will automatically resume direction assist control.



The ICC system is a comfort system, not an emergency warning and collision avoidance system. It can assist the driver, but cannot replace the driver. Even if the ICC system is activated, the driver must

keep a distance from the preceding vehicle and always be responsible for controlling and controlling the vehicle. The driver needs to drive in accordance with laws and regulations. ◀

 Under the following circumstances, the recognition performance of the ICC system may be degraded or unrecognized, and the driver needs to actively control the vehicle and brake in time.

- There are some changes of vehicle posture due to excessive load in the luggage area and other reasons.
- The ICC system cannot identify tricycles and vehicles loaded with irregularly shaped goods.
- The system does not recognize stationary or slowly moving vehicles stably and cannot recognize oncoming vehicles.
- The system cannot recognize vehicles or objects crossing the carriageway.
- If another vehicle jumps the line to the front of vehicle at low speed, ICC may be too late to respond.
- When suddenly accelerating and approaching the vehicle ahead at high speed (an obvious speed difference with the vehicle ahead).
- In some cases (the speed of the preceding vehicle is suddenly too low relative to the speed of the self driving vehicle, the preceding vehicle cuts into the self driving lane at a short distance, etc.), the ICC system does not have enough time to reduce the relative speed.

- If the preceding vehicle suddenly brakes (emergency stop), the ICC system will be unable to respond in time or respond too slowly. The driver will not receive a takeover request in this case.
- At a sharp turn, e.g. a serpentine road, ICC system cannot detect the preceding vehicle normally due to the visual field limit of medium-range radar, which may lead to the acceleration of ICC vehicle.
- When the vehicle ahead in the adjacent lane jumps into the route of ICC vehicle, detection may be affected or delayed in some environments such as low reflection intensity of targets (tricycles), electromagnetic interference, etc., resulting in the ICC system unable to identify targets or accurately calculate the distance from the preceding vehicle. Under such circumstances, the ICC system will have no response or braking delay.
- When the ICC system follows the preceding vehicle to cross the intersection, your vehicle will move laterally with the preceding vehicle. There is risk of side collision with the adjacent lane. ◀

 The driver should adjust the following distance according to the traffic flow ahead, the weather conditions, such as rain and snow, and make proper settings for the ICC system. The driver should be able to actively control the vehicle at any time to ensure driving safety. ◀

 Do not use the ICC system under heavy load. ◀

1

2

3

4

5

6

7

8

 If ICC is activated when the vehicle is stationary, the system will recognize the static obstacle ahead as vehicle and keep still so as to ensure the safe starting of vehicle and avoid the collision with the stationary target due to unexpected starting. Static targets include but are not limited to speed bumps, trees, people, railings, etc. ◀

 When the ICC system works, if the driver applies the accelerator pedal, the vehicle will be taken over by the driver, and respond to the driver's acceleration desire. The ICC system's control function will not work. ◀

 When entering/exiting a curve, the target selection may be delayed or disturbed. ICC may have unexpected braking or late braking. ◀

 If the distance between the ICC vehicle and the adjacent lane is too small (or the vehicle on the adjacent lane is too close to the lane of ICC vehicle), the ICC system may react to the vehicle and brake. ◀

 The visual field of the front camera shall not be blocked by pollutants. Especially, when it's completely covered by snow, the ICC system will exit, and the information of system exiting will be displayed to the driver through the instrument cluster. ◀

 The installation of the front camera may be affected by vibration or impact, which will degrade the system performance. In that case, it is necessary to recalibrate the front camera. ◀

 In following situations, the driver must be especially alert:

- When the ICC system is activated and confirmed to start with the vehicle stationary, if there are children, animals, tricycles or obstacles ahead of vehicle, the ICC system cannot detect and identify them, and there is a serious collision risk. The driver must confirm the area ahead of vehicle is safe before activating the ICC system to control the vehicle to start.
- If the left turn signal lamp is turned on when overtaking from the left, the ICC system will automatically accelerate the vehicle and shorten the distance to the preceding vehicle. If the vehicle enters the overtaking lane and there is no vehicle ahead, the ICC system will automatically accelerate to the set cruise speed.
- The ICC system cannot detect the items loaded or accessories mounted on the target vehicle that protrude from its side, rear end or roof. If the preceding vehicle has the above-mentioned special load or equipment, the ICC system must be turned off when overtaking such vehicles.
- Towing a trailer will reduce the dynamics of the ICC system.
- For safety concern, do not use the ICC system when the visibility is poor, or when driving along slopes and curved sections, or on slippery roads (such as snow, ice, moisture or water sections).
- After the system requires the driver to take over the vehicle, if the vehicle

continues to move, the driver must apply the brake pedal to brake.

- If the driver is prompted to take over the vehicle on the instrument cluster display, the driver must immediately control the distance from the preceding vehicle.
- The driver must always be ready to control the vehicle by acceleration or braking.
- The front camera is installed behind the windshield of the vehicle. If the front camera is covered by dirt, which makes the ICC system unable to work, the instrument cluster display will display a text prompt. Timely clean or go to Geely Automobile Service for inspection and maintenance.
- The front and surrounding area of the front camera shall not be blocked by other objects (such as license plate cover), otherwise the ICC system may be affected.
- Structural modifications to vehicles, such as lowering the ride height or changing the front license plate mounting plate, may affect the ICC system. ◀



Under the following road conditions, the performance of ICC direction assist will degrade or fail to work. The driver should keep alert.

- The ICC system is inapplicable to roads with excessively small curve radius.
- The ICC system is inapplicable to roads with invisible lane lines.
- The ICC system is inapplicable to intersections of roads.
- The ICC system is inapplicable to roads with vehicle marks (e.g., tire marks).

- The ICC system is inapplicable to roads of which the lanes increase or decrease.
- The ICC system is inapplicable to roads that the original lane and the new lane have large difference.
- The ICC system may recognize road edges (wall, guardrail, curb, grassland, green belt, asphalt seam connection) as lane lines to work.
- The ICC system is inapplicable to pavements with potholes, bumps, undulations.
- The ICC system cannot recognize road signs (cones), so it is not applicable to construction pavement.
- The ICC system cannot be applied to sudden changes in light, including but not limited to entering/exiting the tunnel.
- The ICC system is inapplicable to ultra-wide/ultra-narrow roads.
- The ICC system is inapplicable to zigzag roads.
- The ICC system is inapplicable to steep downhill roads.
- The ICC system is inapplicable to bad weather with reduced visibility. ◀

At the entrance of highway or trunk road, due to the change of road, The ICC system cannot change lane and the function may be degraded. Only ACC is available.

The ICC system cannot work under complex road conditions, e. g.: severely congested road, complicated traffic changes, crossing, intersections, ramps, lost lane lines, etc. The driver needs to supervise and take control of the function. The ICC system only provides comfort experience under suitable

1

2

3

4

5

6

7

8

road conditions. The driver should be fully responsible for safe driving.

Function selection

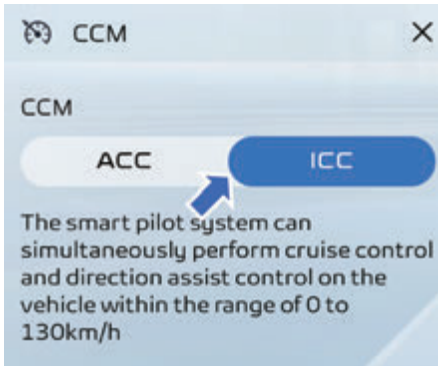

On the multimedia display screen, click Set up → Auxiliary Driving → CCM in turn, and enable/disable the intelligent navigation function in this interface.

Function activation

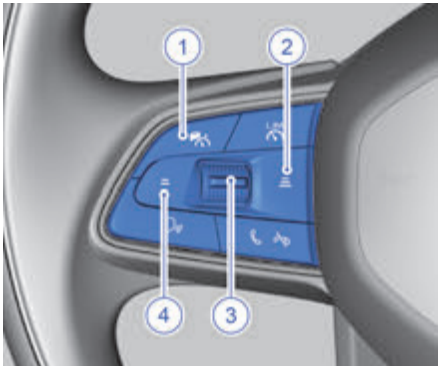

The ICC control button is located on the left side of the steering wheel.

1. ICC button

Press and release this button to start, stop and exit the ICC system.

2. Inter-vehicle interval increasing button

Press and release this button to increase the following interval of the ICC system.

3. Speed adjustment and setting button

- Push the button up

Push and release: cruise speed +1km/h or resume the cruise speed originally set by the driver.

Push and hold: cruise speed +5km/h.

- Push the button down

Push and release: cruise speed -1 km/h.

Push and hold: cruise speed -5km/h.

4. Inter-vehicle interval decreasing button

Press and release this button to decrease the following interval of the ICC system.



Activate the ICC system, the following conditions must be met:

- Press the ICC button to enable the ICC system.
- The gear is in the drive gear (D).
- The ready for operation indicator on the instrument cluster is on.
- The four doors, trunk and front compartment hood are all closed.
- The vehicle is in motion, and the brake pedal is not applied.
- No fault on brake disc.
- The front camera has no problems such as high temperature, dirt or failure.
- The ESC system is on.
- EPB is released.
- The driver fastens the seat belt. ◀

1. When the vehicle is stationary, activate the ICC system as follows:

- Enable the ICC system, and the status indicator of the ICC system in the instrument cluster is on in white.
 - Depress the brake pedal or activate the AUTO HOLD function.
 - Push the speed adjustment and setting button to activate the ICC system.
 - When the brake pedal is released, the ICC system can continue to keep the vehicle stationary.
 - Push the speed adjustment and setting button up again or depress the accelerator pedal to make the ICC system control the vehicle to start.
2. When the vehicle is moving, activate the ICC system as follows:
- Enable the ICC system, and the status indicator of the ICC system in the instrument cluster is on in white.
 - Push the speed adjustment and setting button to activate the ICC system.

When the vehicle follows the preceding vehicle at a low speed, the lane line is blocked by the preceding vehicle or the lane line is temporarily lost. The ICC system can conduct lateral control according to the driving track of the preceding vehicle to maintain the longitudinal and transverse work. Then, the driver needs to be alert at all times.

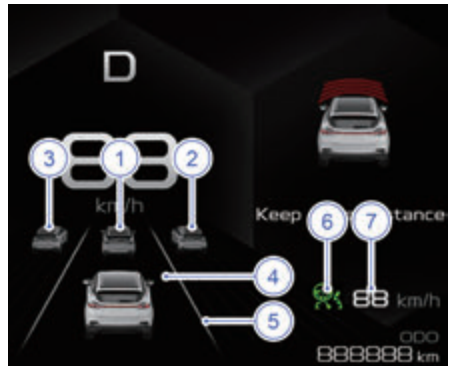

Preceding vehicle 1: Gray when ICC system is not activated; It is blue when ICC system is activated; The ICC system shall be yellow or red when it is activated and is too close to the self owned vehicle.

Preceding vehicle 2/3: Gray when the ICC system is not activated; White when the ICC system is activated; Not displayed when the ICC system fails.

Lane shading 4: Low light when the ICC system is not activated; High light when the ICC system is activated.

Lane line 5: When the system does not detect any lane line, no lane line is displayed. When the lane keeping assist system is not activated, the lane line is displayed in gray. When the lane keeping assist system is intervened by the steering wheel torque, the lane line is displayed in blue. When the lane keeping assist system alarms, the lane line is displayed in red.

The curvature of lane line may be detected inaccurate due to limited sensor performance, e.g., straight road is displayed as curved road.

ICC status indicator 6: White when ICC system is not activated; Green when the ICC system simultaneously performs cruise

control and lane keeping control; Yellow-green when the ICC system only performs cruise control; Gray when the ICC system fails.

Set speed 7: if the ICC system function is not activated, the set speed 7 is black. If the ICC system function is activated, the set speed 7 is green. In addition, if the ICC system is turned on, after pressing the main switch, the set speed 7 is "- km/h" and black.

Cruise control system

The cruise setting speed adjustment and inter-vehicle interval adjustment methods of the ICC system are the same as those of the ACC system. The relevant ICC system function modes and precautions are the same as those of the ACC system. For details, please refer to the introduction of "Adaptive Cruise Control System (ACC)".

Direction assist control

When the ICC system is activated, identify the lane lines on both sides. The system can control the self driving vehicle to keep driving in the middle of the lane. Then, the lane shading in the instrument will be highlighted.

If one or both lane lines are lost, the intelligent pilot will no longer maintain the middle control of the lane, but the cruise control will continue to maintain. Then, the ICC status indicator will be on in yellow. If the intelligent pilot recognizes the lane lines on both sides again, it will automatically resume the lane middle control. Then, the ICC status indicator is on in green.

When the vehicle follows the preceding vehicle at a low speed, the lane line is blocked by the preceding vehicle or lost temporarily. The ICC system can control the

direction according to the driving track of the vehicle in front, and the self driving vehicle follows the preceding vehicle to slowly move laterally. Therefore, the ICC system can continue to maintain cruise control and direction control. Then, drivers need to pay special attention to the traffic conditions on the side of their own vehicles.

Release warning



The precondition of the ICC system is that the driver holds the steering wheel with both hands. The system will continuously monitor this. If the release time exceeds a certain time, the instrument cluster will display a release warning message to remind the driver to hold the steering wheel with both hands. If the driver has not responded, the ICC system will exit after the release warning message is displayed for the second time.

If the driver puts his hand on the steering wheel gently for a long time, a release warning may appear. Then, hold the steering wheel tightly.

Detection problems

The detection range of the front camera is limited. In some cases, the front camera may not be able to detect the vehicle or delay the time to detect the vehicle.

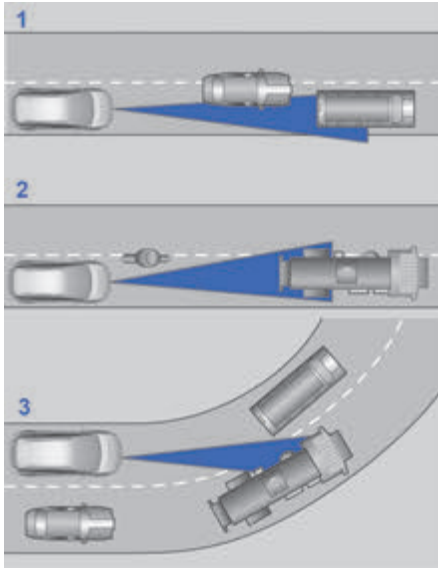

Detection problems may occur in the following situations:

1. Vehicles move slowly along the driver's lane. The system can only detect the vehicle that has fully entered the driver's lane.
2. When the preceding vehicle is a large truck, the time of detecting the vehicle may be delayed.
3. When the driver enters or exits a curve on the road, detection problems related to the preceding vehicle may occur.

Under these circumstances, the driver shall keep alert and take emergency measures and temporarily shut down the ICC system when necessary.

The detectability of front camera is limited. In some cases, the front camera may not be able to accurately judge lane lines, and it's easy to be interfered by the environment.

Lane line detection problems may occur in the following situations:

- Lane lines are not constructed according to national standards and cannot be recognized.
- The clarity and contrast of lane lines are low and cannot be recognized.
- The surface of lane lines is covered by dust, water, snow, etc., and cannot be recognized.
- In rain and snow days, the wheel marks and braking marks of preceding vehicles may be recognized as lane lines.
- Road boundaries, curbs, etc., may be recognized as lane lines.
- Continuous lane-line-shaped shadows on road, such as the shadow of railings, may be recognized as lane lines.

Lane keeping assist (LKA)*

The lane keeping assist system can identify lane lines, pedestrians, curbs, and incoming vehicles in front/behind through the front camera within the range of 60~180 km/h, and calculate the distance between self driving vehicles and the left and right lane lines, as well as the front and rear incoming vehicles. When the vehicle deviates from the lane or will collide with pedestrians and vehicles in the adjacent lane, the system will provide auxiliary correction force to prevent deviation from the lane, mitigate or avoid collision, or remind the driver to control the vehicle in the lane. The lane keeping assistance system consists of lane

1

2

3

4

5

6

7

8

departure alarm, lane departure assistance and lane keeping system.

 When the vehicle is powered on, the lane keeping assist system will start self-check, and the system function is not available at this stage. ◀

 Make sure the front camera surface is clean. Road conditions such as unclean front camera, bad weather and fading lane markings may affect the performance of the lane keeping assist system. ◀

 The lane keeping assist system is only suitable for the use on expressways and urban main roads, and the driver should be concentrated on driving. When using the lane keeping assist system, hold the steering wheel and pay attention to the road and surrounding traffic. Do not use this function in urban streets, construction areas, narrow paths, or roads where cyclists or pedestrians exist. Do not rely on the lane keeping assist system to determine the appropriate driving route. Be sure to take measures at any time and in a timely manner. Failure to follow these instructions may result in serious property damage and personal injury. ◀

 When the electronic stability control system (ESC) is off, the lane departure prevention (LDP) and the lane keeping system (LKS) cannot work. ◀

Function type

Lane departure warning (LDW)

The lane departure warning (LDW) warns the driver when the vehicle deviates from

the lane unconsciously. Unconscious lane departure includes the already happened lane departure and the imminent lane departure.

Lane departure prevention (LDP)

As for lane departure prevention (LDP), when the vehicle approaches lane lines and there is a risk of deviation, the system will assist the driver to control the vehicle back to the lane by applying torque to steering wheel.

Lane keeping system (LKS)*

LKS will assist the driver to control the vehicle to keep driving in the middle of the lane by applying torque to the steering wheel.

LKS can only work when the left and right lane lines are recognized at the same time.

 The driver shall keep his attention and judgment at all times to ensure the safe driving of the vehicle, keep a proper distance from other vehicles, and comply with current traffic laws and regulations. ◀

Function selection

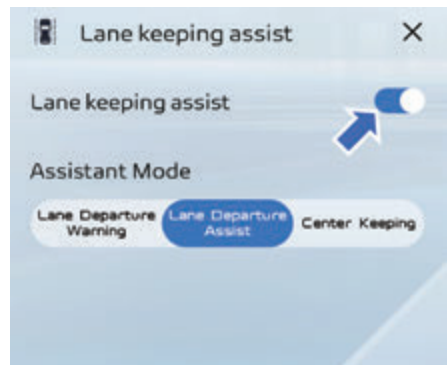

On the multimedia display, click Set up → Assisted Driving → Lane keeping assist in turn. In the interface, select to enable/

disable the departure warning, departure assistance and centering control functions. When lane keeping assist is enabled, the lane keeping assist (LKA) status indicator on the instrument cluster display will be on in green.

 Lane departure warning (LDW), lane departure prevention (LDP) and lane keeping system (LKS) will memorize the driver's selection. ◀

Lane keeping assist system display

 The curvature of lane line may be detected inaccurate due to limited sensor performance, e. g., straight road is displayed as curved road. ◀

The lane keeping assist system will display the information of system working status on the instrument cluster.



When lane keeping assist is enabled, the lane keeping assist (LKA) status indicator 1 is on in green. When lane keep assist is disabled, the LKA status indicator 1 is on in yellow (with OFF). In case of any failure of LKA, the status indicator 1 of LKA will be on in yellow (without OFF).

When the lane keeping assist system does not detect the lane lines, the lane lines 2 are not displayed.

When LKA system is not activated, the lane lines 2 are displayed in gray.

When LKA system is on standby, the lane lines 2 are displayed in white.

When the lane departure warning system works, the lane lines 2 are displayed in red.

When LKA system is intervened with steering wheel torque, the lane lines 2 are displayed in blue.

Release warning



When the lane keeping assist system is activated, the driver shall always keep two hands on the steering wheel. If your hands are not detected on the steering wheel by the system at the first activation of the lane keeping assist, no reminder message will appear on the instrument cluster. If the lane keeping assist is activated again in the next period of time, and the system still does not detect the driver's hands on the steering wheel, the system requests and gives an audible warning, and displays a reminder on the instrument cluster.

1

2

3

4

5

6

7

8

 When both hands are detected, the reminder displayed on the instrument cluster will disappear and the system will continue to work. ◀

 Abnormal tire pressure, incorrect four-wheel alignment parameters, inconsistent tires and incorrect tire model, etc., may result in abnormal performance of LKA system. The driver shall use the assist system when the vehicle is in normal condition. ◀

System limitation

Under the following road conditions, the LKA performance will degrade or fail to work. The driver should keep alert:

- The lane keeping assist system is inapplicable to roads with excessively small curve radius.
- The lane keeping assist system is inapplicable to roads with invisible lane lines.
- The lane keeping assist system is inapplicable to intersections of roads.
- The lane keeping assist system is inapplicable to roads with vehicle marks (e.g., tire marks).
- The lane keeping assist system is inapplicable to roads of which the lanes increase or decrease.
- The lane keeping assist system is inapplicable to roads that the original lane and the new lane have large difference.
- The lane keeping assist system is inapplicable to pavements with potholes, bumps, undulations.
- The lane keeping assist system cannot recognize road signs (cones), so it is not applicable to construction pavement.
- The lane keeping assist system is inapplicable to ultra-wide/ultra-narrow roads.
- The lane keeping assist system is inapplicable to zigzag pavements.
- The lane keeping assist system is inapplicable to bad weather with reduced visibility.
- The view of the front camera shall not be blocked by pollutants. Especially, when it's completely covered by snow, the lane keeping assist system will exit, and the information of system exiting will be displayed to the driver through instrument cluster display.
- The installation of the front camera may be affected by vibration or collision, which may degrade the system performance. In that case, the front camera needs to be recalibrated.

Automatic emergency braking system (AEB) *

By monitoring the distance and relative speed of the front target, the automatic emergency braking system will take warning and braking measures to assist the driver to avoid or mitigate collisions when the driver brakes too late, the braking force is too small or there is no braking measure.

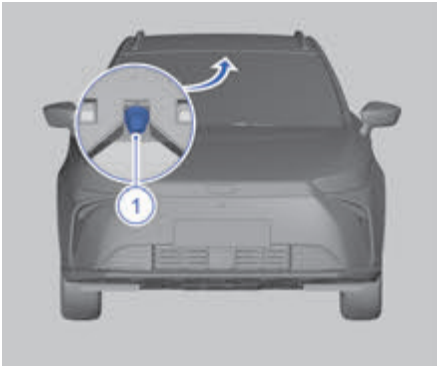

The sensors used by the automatic emergency braking (AEB) system are:

1. Front camera*

! No automatic system can guarantee 100% normal operation under any circumstances. Therefore, please do not intentionally drive the vehicle toward people or objects to test the FCW/AEB performance. Otherwise, it may cause traffic accidents and serious casualties. ◀

! The system is only an auxiliary function and cannot detect all pedestrians (if equipped with a front camera), cyclists (if equipped with a front camera and has the function of identifying cyclists) or vehicles in all cases. The driver is always responsible for driving correctly and needs to keep a safe distance. ◀

! The system can only provide alarm and braking assistance. The driver needs to be alert at all times and always be responsible for the safe driving of the vehicle, and abide by the current laws and traffic regulations. ◀

! For safety concern, the system cannot work when the driver doesn't wear the seat belt. ◀

! Usually, AEB system works in the background unnoticeable to the driver. When the system recognizes a danger, it will warn or brake to protect the occupants. Due to system performance limitations, false triggers may occur. The driver must pay close attention to the surrounding at all times. ◀

! Be aware that the front camera (if equipped) cannot detect dangerous obstacles ahead in all cases. Severe weather conditions, such as rain, snow, fog, etc., will degrade the system performance. In such cases, some targets will not be detected, or detected too late by the system. ◀

! In some scenes, the detection of the front camera may be affected, such as roads with fences, tunnels, vehicles driving in and out ahead, sharp turns. ◀

! The system will not react to animals, small vehicles (such as tricycles), vehicles with irregular appearance, pedestrians (if not equipped with a front camera), cyclists (if not equipped with a front camera), oncoming and crossing vehicles. ◀

! For safety reasons, the implementation of the AEB system requires the support of ESC. When the driver chooses to turn off the ESC system, the AEB system will not work. ◀

1

2

3

4

5

6

7

8

 When the vehicle is impacted or strongly vibrated, the position of the radar may deviate, resulting in degraded system performance. In severe cases, the system will give a fault prompt. Then the driver should contact Geely Automobile Service for maintenance as soon as possible. ◀

 Keep the exterior surface of the camera (if equipped with a front camera) clean, otherwise system performance will be affected. In severe cases, AEB cannot work. ◀

 Under complicated driving conditions, the system may brake unnecessarily. For example, when there is water spraying or splashing at construction site, railway track, manhole cover, underground garage or ahead of vehicle. ◀

 For the effective targets identified by the system, the system may not always achieve the same performance level according to different vehicles, pedestrians (if equipped with a front camera), cyclists (if equipped with a front camera and capable of identifying cyclists), scenes and road conditions. ◀

 If the driver operates the accelerator pedal or takes steering intervention during automatic emergency braking, the system will exit automatic emergency braking even if collision cannot be avoided. ◀

 While the automatic braking is being triggered, the driver needs a larger force to depress brake pedal. ◀

 Strong sunlight, reflection and extreme light contrast may make it difficult for the driver to see the visual warning signal, and may also affect the detection function of the front camera (if equipped with a front camera). ◀

 The view of the front camera (if equipped) is limited. In some cases, the time for the system to detect vehicles, pedestrians (if equipped with a front camera) or cyclists (if equipped with a front camera) will be delayed than expected or the system will not detect vehicles, pedestrians (if equipped with a front camera) or cyclists (if equipped with a front camera) and the function of identifying cyclists). ◀

 Be sure to keep the front camera (if equipped with a front camera) and its surroundings clean to ensure that the system works properly. Do not place or paste any object around the front of the front camera (if equipped with a front camera). Otherwise, the system will not work properly. ◀

 When the front camera (if equipped with a front camera) is blocked or the front camera function is limited, the automatic emergency braking performance may be degraded or even unavailable. ◀

 On slippery roads, the braking distance of vehicle is lengthened, which will reduce the anti-collision performance of AEB. ◀

 If the temperature inside the vehicle is very high, the front camera may be

temporarily turned off, and the system may not issue a warning (if equipped with a front camera). ◀

 This function will not be enabled at low vehicle speed, so the system will not intervene and brake when the vehicle approaches the preceding vehicle or pedestrian at low speed, for example, when parking. For example, when parking. ◀

Enabling function



On the multimedia display screen, click Set up → Auxiliary Driving → AEB in turn, and the automatic emergency braking and front collision warning functions can be enabled or disabled in this interface.



On the multimedia display screen, click Set up → Auxiliary Driving → AEB in turn, and the alarm sensitivity can be set in this interface. The alarm sensitivity will memorize the driver's selection, and it is unnecessary to select each time when getting on the vehicle.

The alarm sensitivity is divided into three levels: early, moderate and late.

Early sensitivity: it indicates that the alarm distance is far and the alarm time is relatively early.

Moderate sensitivity: it indicates that the alarm distance is moderate, and the alarm time is between low and high.

Late sensitivity: it indicates that the alarm distance is close and the alarm time is relatively late.

If the driver thinks the alarm is too frequent, a lower sensitivity can be selected to reduce the total alarms.

Functions

When a danger is judged by the system, the system will assist the driver in the following ways:

- Safe distance alarm

The safe distance alarm works in a non-emergency situation. When the vehicle speed reaches 65 km/h or above, it reminds the driver that the following distance is too small, and the driver should adjust the driving behavior and keep a proper distance.
- Front collision warning

When the vehicle speed reaches 30 km/h or above, the system thinks there is a potential collision risk, and will remind the driver of the potential collision risk

1

2

3

4

5

6

7

8

through the alarm sound, alarm picture on the instrument cluster interface, etc.

- Emergency brake assist
When the vehicle speed reaches 30 km/h or above, if a danger occurs, but the driver's current braking force is too small, the system will assist the driver to increase braking force to avoid or mitigate the collision.
- Automatic emergency braking (AEB)
When a danger occurs and the driver fails to brake effectively, the system will intervene in time to carry out automatic emergency braking to avoid or mitigate the collision. Automatic emergency braking can decrease 60 km/h at most.

Function activation



When the AEB system is triggered, there will be a picture and text prompt on the instrument cluster, accompanied by an alarm sound.

Automatic emergency braking (AEB) system for pedestrian*



The automatic emergency braking system for pedestrian can avoid or reduce the collision with pedestrians. Main application scenes: Pedestrians cross the road.

When the pedestrian warning function detects a collision risk, it will remind the driver to react in time through sound and pictures on the instrument cluster to reduce the collision risk.

The working speed under this function is 5-80 km/h.

When the automatic emergency braking of pedestrians is triggered, there will be pictures and text prompts on the instrument cluster, accompanied by an alarm sound.

Emergency braking function of two wheeled vehicle*



The emergency braking function of two wheeled vehicles is to avoid or mitigate the collision with two wheeled vehicles passing through the self lane.

The emergency braking function of two wheeled vehicle includes as follows:

- Pre-filling: pretreatment of the braking system to achieve faster deceleration and decompression.
- Two wheeled vehicle pre-alarm: when the system detects that there is a risk of collision with the two wheeled vehicle target in front of it, it sends out sound and picture alarm to remind the driver to react.
- Automatic emergency braking - partial braking: trigger the automatic partial braking in case of emergency collision with two wheeled vehicles and no response from the driver.
- Automatic emergency braking - full force braking: trigger full force braking in case of emergency collision with two wheeled vehicles and no response from the driver.

- When the emergency braking function of the two wheeled vehicle of the AEB system is triggered, there will be a picture and text prompt on the display of the instrument cluster, accompanied by an alarm sound.
- The working speed under this function is 5-80 km/h.

Target detection

The automatic emergency braking system (AEB) can detect passenger cars, trucks, buses and other vehicles, pedestrians (if equipped with a front camera) and cyclists (if equipped with a front camera and has the function of identifying cyclists).

Vehicles

The Automatic Emergency Braking (AEB) system can detect most vehicles that are stationary or moving in the same direction as the vehicle.

Only when the front combination lamps of vehicle turn on normally can the vehicles within a certain range be detected at night.

Pedestrians*

Only when the system detects the unmistakable information of the pedestrian's shape, can it achieve the best working effect. It means that the system can clearly recognize human's head, arms, shoulders, thighs, upper body, lower body, etc., in combination with standard human movement.

The system can detect the pedestrians in contrast to the background, for example, the clothing color of pedestrians is in sharp contrast with the environment color.

If the contrast is low, the pedestrian will be detected late or not detected at all. It means

1

2

3

4

5

6

7

8

that the warning and braking will be delayed or unachieved.

If a pedestrian is partially blocked, the clothes worn are not easy to be judged as body shape, and if the height is less than 0.8 m, or a large object is carried, he/she can't be detected, which means that braking cannot be achieved.

Cyclist*

The cyclist must be an adult, and the bicycle must be designed for adults. Only when the system detects the unmistakable outline information of human body and bicycle, can it achieve the best working effect. It means that the system can clearly recognize bicycle, head, arms, shoulders, thighs, upper body, lower body, etc., in combination with standard human movement.

Partial block, poor background contrast or cyclists loaded with large goods cannot be detected by the system, which means that braking cannot be realized.

Shutdown and fault

When AEB is off, the AEB OFF indicator on the instrument cluster will be on. When AEB fails, the AEB fault warning lamp on the instrument cluster will be on.

Rear side radar assist system*

The system detects the rear side of the vehicle based on the rear medium-range radar on both sides of rear bumper, to realize lane change assist (LCA) (including blind spot monitoring function), collision mitigation support rear (CMSR), door opening warning (DOW) and rear cross traffic alert (RCTA).

 When the vehicle is powered on, the rear side radar assist system will start

self-check, and the system function is not available at this stage. ◀



On the multimedia display screen, click Set up → Assisted Driving → Rear side radar sensor in turn, and select the opening or closing of each function in this interface as required. All function switches remain in the last setting state.

The system will prompt the driver of driving safety via the on/flashing of blind spot monitoring indicator on the exterior rearview mirror, instrument cluster prompt, sound alarm, flashing of hazard warning lamp, etc. The system works normally when the blind spot monitoring status indicator on the instrument cluster display turns green when the vehicle starts. When the blind spot monitoring status indicator is red, the system fails.



- Please keep the both sides of rear bumper surface clean;
- This system is only for driver assist, and it cannot replace the driver's safe driving.

- Do not dismantle or exchange the rear side medium-range radar. ◀

Lane change assist (LCA)

The lane change assist function covers the blind spot area and the rear side quick oncoming car area, to assist and alert the driver against blind spots and rear oncoming cars when driving, especially when turning or changing lanes. The assist function works when changing lane at 15~150 km/h.

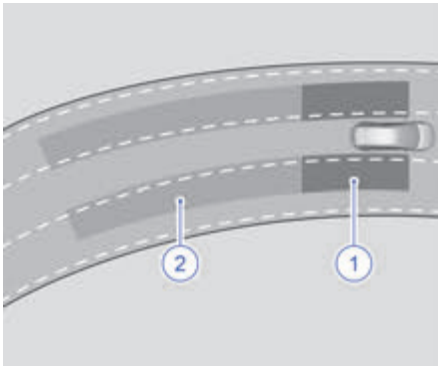

1. Blind spot area
2. Areas with quick oncoming cars



When the warning condition is met, the blind spot monitoring indicator on the exterior rearview mirror is on or flashes. If the sound

warning function is turned on in advance in the multimedia display, the system will also give a sound warning.

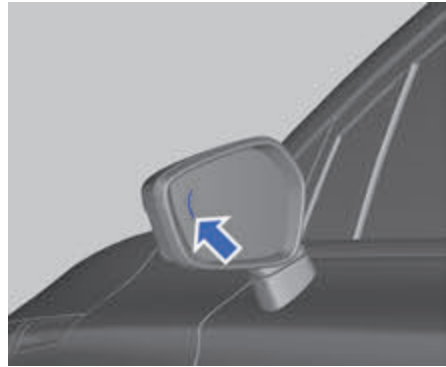

In some cases, it's difficult for the lane change warning function to assist the driver. Possible situations include:

- Bad weather such as rain or snow.
- It doesn't work on stationary targets.
- It doesn't work on pedestrians and bicycles.
- Sharp turns and open areas.

Collision mitigation support rear (CMSR)

The collision mitigation support rear function can monitor the targets behind the vehicle. When a vehicle is detected quickly approaching behind, the hazard warning lamp turns on to remind the rear vehicle to slow down or keep a safe distance. When a risk of rear-end collision exists, if the vehicle features the active pretension seat belt, then the driver's seat belt will be actively tensioned.

1

2

3

4

5

6

7

8



The collision mitigation support rear function works in the P/N/D gear, and the vehicle does not slip backwards. The detection of the rear approaching targets includes the following targets, etc.

- Motor vehicle
- Electric vehicle or motorcycle



In some cases, it's difficult for the collision mitigation support rear function to help. Possible situations include:

- The rear vehicle changes lane at the last minute.
- Too late to detect a vehicle coming from behind in scenes such as sharp bends and ramps.

- The relative speed of rear vehicle exceeds 72 km/h or the relative speed is less than 10 km/h.

 Collision mitigation support rear function cannot avoid collision. The driver should pay attention to the warning and take actions accordingly for safe drive.



Door opening warning (DOW)

When the vehicle is stationary or at low speed, the rear side middle-range radar detects the approaching movable targets at the rear side. When a potential collision risk exists to open the door, the blind spot monitoring indicator on the exterior rearview mirror is on or flashes and gives a sound warning to remind the driver of the risk to open the door.

The door opening warning function mainly detects the following targets:

- Motor vehicle
- Electric vehicle or motorcycle
- Bicycle
- Pedestrians (detection performance is not guaranteed)



In some cases, it's difficult for the door opening warning function to assist the driver. Possible situations include:

- Bad weather such as rain or snow.
- It doesn't work on stationary or slow targets.
- Vehicles approaching or leaving quickly.

 After the start and stop button is turned off for 3 minutes or the vehicle is locked and powered off, the door opening warning function stops working. ◀

Rear cross traffic alert (RCTA)

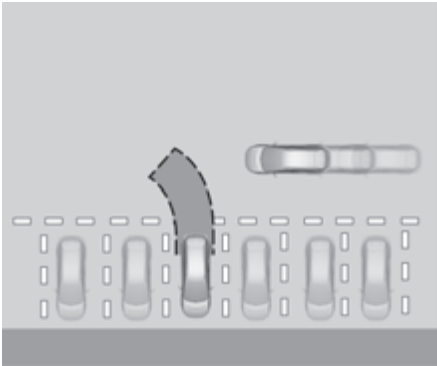

The rear cross traffic alert uses the rear side medium-range radar to monitor approaching targets. When a collision risk is detected between the vehicle and rear vehicles, motorcycles, bicycles, pedestrians, etc., the rear cross traffic alert gives a clear and accurate alarm to remind the driver of the risk.



This function works in the low-speed reversing scene. When a possible collision is detected, the rear cross traffic alert will provide the driver with light alarm (the blind spot monitoring indicator on exterior rearview mirror/danger warning on multimedia display) and sound alarm (warning sound from multimedia display), to prevent the vehicle from colliding with the rear crossing vehicles when leaving the parking area.

Intelligent high beam control system (IHBC)*

The intelligent high beam control system (IHBC) can automatically toggle between high and low beams at night. Based on the light source information detected by the

1

2

3

4

5

6

7

8

front camera above the windshield, the system automatically toggles between high beam and low beam according to the light of vehicles in the same or opposite direction, as well as the ambient light. Generally, this function automatically toggles the high beam to low beam when the headlights of the oncoming vehicle, the taillights of the forward preceding vehicle or other light sources are detected to avoid the glare of high beam to surrounding traffic participants. After the vehicles meet, overtake or there is no ambient light source around, the low beam is automatically toggled to high beam.

Function enabling/activation



On the multimedia display screen, click Set up → Auxiliary Driving → Intelligent high beam control in turn. In this interface, select to enable or disable the intelligent high beam function.

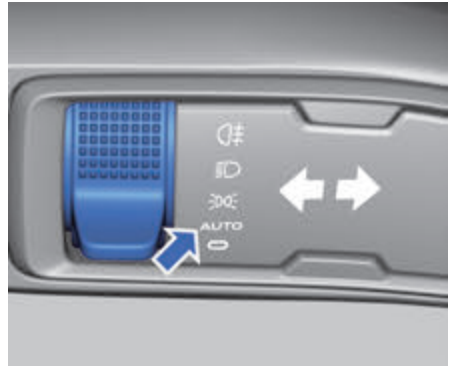

Turn the light control combination switch to AUTO.

At night, after the front combination lamps automatically turn on, IHBC system is activated automatically.

After the IHBC system is activated, the IHBC system will recommend to turn on the high beam if all the following conditions are met:

1. Vehicle speed ≥ 40 km/h;
2. No relevant traffic participants or other light sources were detected.

The IHBC system will recommend to turn on the low beam when any of the following conditions are met:

1. Vehicle speed ≤ 25 km/h;
2. Relevant traffic participants or other light sources are detected.

 When IHBC system has recommended to turn on the high beam, and the vehicle speed maintains in 25~40 km/h, the IHBC system can still remain the high beam until the light source information is detected and IHBC will recommend to turn on the low beam. ◀

Function display

When the IHBC system controls the high and low beams of the vehicle's headlights, the indicator is on in white, and when the IHBC system fails, the IHBC intelligent high beam status indicator is on in yellow.

 When the driver operates the light control combination switch to select the high beam, the driver's selection will take priority. ◀

 IHBC is an auxiliary function for light control. It is recommended to use this function when driving on high-speed roads, but the system cannot completely replace the driver. The driver should always switch the high and low beam lights according to the road laws and regulations and according to the changes in the road environment. ◀

 In the following example cases, the system does not work or only works to a limited extent, which may require a personal response from the driver:

- In rainstorm, snowstorm, dense fog and other climatic conditions that are extremely unfavorable to driving.
- Traffic participants (such as pedestrians, cyclists) with poor illumination, railway or waterway traffic near the road, and the road infested with wild animals.
- In an environment with strong reflective scenery (such as traffic signs on highways).
- When the windshield is fogged, dirty or covered by labels, ornaments, etc. ◀

Driver assist system

Service brake

The actual braking distance will be different due to road conditions, vehicle weight and applied braking force. Keep enough distance from the preceding vehicle to avoid inching and emergency braking.

 Do not add non-original accessories to avoid affecting vehicle performance and causing traffic accidents. ◀

 When depressing the brake pedal, if there is a sharp metal friction sound at the brake of the vehicle, go to Geely Service as soon as possible for maintenance. ◀

 Do not depress the brake pedal during driving. It may cause wear and overheating of the braking parts and prolong the braking distance. ◀

Recuperating

The braking system of the vehicle also has the function of energy recuperating: when the vehicle is in the drive gear (D), when sliding or braking, the kinetic energy is converted into the electric energy, which is charged into the power battery to recover energy and improve the driving range of the vehicle.

1

2

3

4

5

6

7

8

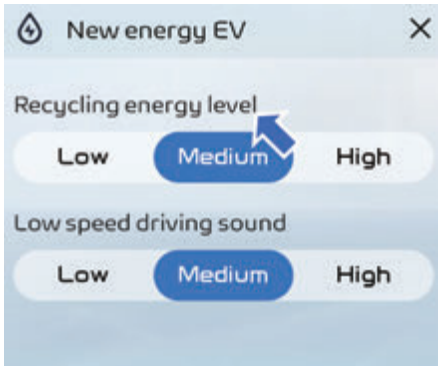

On the multimedia display screen, click Set up → Vehicle Setting → New Energy EV in turn. The function of energy recovery can be set in this interface. There are three modes of energy recovery: low, medium and high.

▶ It is normal that the vehicle slows down with slight jerk and motor noise. When switching to the economy mode, the energy recovery will increase when the vehicle skids or brakes. ◀

▶ When the power battery is full and the power battery temperature is too high or too low, the energy recuperating is automatically reduced to prevent battery damage. ◀

Parking brake

Electric parking brake (EPB)



EPB manual release

Turn the vehicle power supply to ON, depress the brake pedal, and press the EPB switch at the same time to release EPB.

EPB automatic release

Start the vehicle, close the left front door, fasten the safety belt, EPB has been pulled up, the vehicle is in the driving gear, gently depress the accelerator pedal, EPB will automatically release, and the parking brake warning lamp on the instrument cluster display will be off.

EPB manual parking

Turn the vehicle power supply in the ON gear, pull down the EPB switch when the vehicle is stationary, and the manual parking is completed, and the parking brake warning lamp on the instrument cluster display is on.

▶ Once EPB is activated, the electronic parking brake (EPB) status indicator on the instrument cluster display is on. If the warning lamp is off, contact Geely Automobile Service for maintenance as soon as possible. ◀

EPB automatic parking

When the vehicle power supply is in the OFF gear, EPB will automatically park.

Disable EPB automatic parking function (vehicle washing mode)

In vehicle washing, if the automatic activation function of the electric parking brake is not required, the EPB can be released before the vehicle power is turned off, and then the EPB switch can be pressed until the vehicle power is turned off, then the vehicle will not park automatically.



- If the warning lamp of the electric parking brake system is on after the automatic parking function is disabled, it indicates that the electric parking brake system is faulty. Please contact Geely Automobile Service for maintenance.
- If the electronic parking brake system cannot be enabled, the rear wheels should be locked to prevent the vehicle from moving, when necessary. ◀



Improper use of the EPB may cause personal injury or death. ◀

Do not use the electric parking brake for the service brake of the vehicle except in an emergency. In the state of electric parking brake, do not depress the accelerator pedal when the vehicle is started and the driving gear is engaged.



When the EPB is released, the vehicle will lose its parking function. To avoid vehicle damage, serious personal injury, do not perform this operation on a sloping road.



When the vehicle is washed automatically and needs to move, the vehicle needs to be started, the gear is switched to neutral (N), and the EPB is released manually. ◀

AUTO HOLD

The AUTO HOLD function can help the driver to start more comfortably on sloping roads. After releasing the brake pedal, the system holds braking, so that the driver has enough time to depress the accelerator pedal to start, reducing the impact of sliding.



Depending on the stress, the vehicle may move even when AUTO HOLD is activated. ◀



On the multimedia display screen, click Set up → Vehicle Setting → Vehicle control in turn. In this interface, select to enable or disable the automatic parking function.

AUTO HOLD function enabled

When the power system is in operation, the driver's door is closed, the seat belt is fastened, and the Auto Hold function is enabled through the multimedia display screen.

1

2

3

4

5

6



7

8

AUTO HOLD disabled

Disable the Auto Hold function through the multimedia display, and the Auto Hold function will be off.

AUTO HOLD activation and deactivation

1. Start the vehicle, close the left front door, fasten the safety belt, after the automatic parking function is enabled, the vehicle speed is zero, depress the brake pedal, the automatic parking function is activated, the vehicle is not in the reverse gear (R) and parking gear (P), and the automatic vehicle hold (AVH) status indicator on the instrument cluster display  is on.
2. Lightly depress the accelerator pedal, the parking is automatically released, and the automatic vehicle hold (AVH) status indicator  on the instrument cluster display is off.
3. If not depressing the accelerator pedal for more than 10 minutes, switch to the EPB mode, and the parking brake warning lamp on the display of the instrument cluster will be on.

AUTO HOLD force exit

If the automatic parking function has been activated, unfasten the safety belt, open the driver's door or the power system stops running. At this time, execute EPB electronic parking. The automatic vehicle hold (AVH) status indicator  on the instrument cluster display goes out, and the parking brake warning lamp is on.

Anti-lock braking system (ABS)

The vehicle is equipped with ABS to prevent the wheels from locking when you apply the maximum braking force. In most cases, the steering control performance of the vehicle under emergency braking can be improved.



The braking distance will be longer on rough, gravel or snow covered roads than on normal roads. ◀



During braking, you can feel the continuous "cluck" sound from the engine compartment and the vibration from the brake pedal. This is caused by the normal operation of the anti-lock braking system, not a fault.

When the anti-lock braking system stops working, the feeling of the brake pedal will return to the state of non-anti-lock braking.



Electronic braking-force distribution (EBD)

When the vehicle brakes, the electronic brake-force distribution system (EBD) will automatically adjust the brake force distribution ratio of the front and rear axles to improve the braking efficiency, and cooperate with ABS to improve the braking

stability, thus ensuring the stability of the vehicle.

Electronic stability control (ESC) system

The electronic stability control (ESC) system is a kind of active safety technology that assists the driver in controlling the vehicle. It corrects the instability of the vehicle body and helps prevent accident from applying braking force to the wheels or reducing the power system torque, and guides the vehicle back to the correct route.

 The ESC system is only an auxiliary system, and there are still risks on the slippery and wet road. Please drive carefully. ◀

When the ESC system is enabled, the ESC status indicator will flash on the instrument cluster. This also occurs when the traction control system is activated. You may hear some noise or feel the vibration of brake pedal. This is normal. Continue to steer the vehicle in your desired direction. If a fault of the ESC system is detected, the ESC status indicator will be always on and the system will not work normally. Driving style should be adjusted. ESC will be enabled when the vehicle is started. To keep control of the vehicle direction, the system should always be activated.

ESC OFF



After the vehicle is started, click Set up → Vehicle Setting → Vehicle control in turn on the multimedia display screen in order to enable the ESC SPORT mode in this interface. When the ESC SPORT mode is enabled, ESC will automatically turn off. The ESC SPORT indicator on the instrument cluster display is  on.

When there is insufficient traction force, the ESC can be turned off in the following conditions:

- When it runs on deep snow or soft road.
- When the vehicle is trapped (such as muddy road) and needs to be moved forward and backward.
- When the vehicle travels with tire chains.

ESC activation

Turn off the ESC sport mode again through the multimedia display screen, and the ESC will turn on automatically. Then, the ESC OFF indicator  is off.

Hydraulic brake assist (HBA)

During emergency braking, the HBA system will increase the driver's braking force and reduce the braking distance.

1

2

3

4

5

6

7

8

 The HBA system can only help the driver to increase the braking force. It does not mean that accidents can be avoided. Therefore, you should always keep a safe distance and drive carefully. ◀

Traction control system (TCS)

TCS is used to prevent loss of traction on the drive wheels. When the system detects that the drive wheel is slipping, it will brake the idle drive wheel to prevent the drive wheel from idling.

Hill hold control (HHC)

After starting on the ramp, the driver releases the brake pedal, and the hill hold control (HHC) function can maintain the braking force for about two seconds to effectively prevent rolling.

 The HHC function can only be activated when the electronic stability control system is activated and the parking brake is fully released. ◀

 The HHC function only maintains the brake pressure shortly when the driver releases the brake pedal. If the accelerator pedal isn't pressed or the EPB switch isn't pulled up, the vehicle may slip back on the slope after 2 seconds. Therefore, drive carefully when starting on the uphill! ◀

Hill descent control (HDC)

HDC can actively brake the vehicle when it is going downhill to ensure that the driver can drive down the steep slope safely at a constant speed.



- HDC only plays an auxiliary role. At any time, the driver should be responsible for the safety of the vehicle and keep an eye on the surrounding traffic.
- When the slope is too large, HDC may not be able to keep the vehicle driving down the steep slope at a constant speed. At this time, the vehicle speed can be controlled by pressing the brake pedal. ◀

Turn on/off the system



On the multimedia display screen, click Set up → Vehicle Setting → Vehicle control in turn. In this interface, you can select to enable or disable the HDC function.



- HDC can only be activated when the vehicle speed is less than 35 km/h, and the system will automatically turn off HDC when the vehicle speed is higher than 60 km/h.

- HDC cannot be opened or automatically closed when the brake temperature is too high.
- When the HDC function is enabled on the multimedia display screen, the HDC status indicator on the instrument cluster display screen is not on or yellow, indicating that the HDC system cannot be started. ◀

Electric power steering (EPS)

The electric power steering system monitors the driving speed and adjusts the power assistance in real time to ensure the portability of low-speed steering and the stability of high-speed steering, and improve the sense of safety.

If the steering is still difficult or the EPS fault warning lamp of the instrument cluster is on, contact Geely Service for maintenance.

Park assist system

Park assist system

The parking radar system assists the driver to avoid hitting objects when parking.

Front parking radar*

Parking assist system radar sensors on front bumper can detect barriers 1m away from front part of vehicle at most.

Rear parking radar

Park assist system radar sensors on rear bumper can detect barriers 1.5m away from rear part of vehicle at most.



The parking assist system cannot replace the vision of driver.

- The parking radar system cannot detect objects below the bumper or vehicle, or objects too close or far away from the vehicle.
- The parking radar system may not be able to detect children, pedestrians, cyclists or pets.
- The park assist system cannot detect tiny objects.
- If you do not pay attention to the surrounding conditions of the vehicle during parking, it may cause serious casualties and property damage. Even if the vehicle is equipped with a parking radar system, the driver must carefully observe whether there are obstacles before parking. ◀

How system works

When the park assist system works and obstacles enter the detection range, the detection results will be displayed on multimedia display in color blocks, with buzzer sound to remind. The buzz means

1

2

3

4

5

6

7

8

that there are obstacles in front of (if front parking radar is equipped) or behind the vehicle. The beeps will become more frequent when the vehicle is closer to the obstacle. When the distance is less than 30 cm, a continuous beep will be heard.

 Due to environmental factors, the detection performance of radar sensors of parking assist system may be degraded in hot, extremely cold or humid weather. ◀

When system cannot work normally

Please be aware that the radar sensor of parking assist system may not alarm or may give wrong alarms under the following conditions:

When barriers cannot be detected

- The radar sensor of parking assist system cannot detect net-shaped barriers like iron wires, mooring ropes and blocking net.
- The radar sensor of parking assist system cannot detect low barriers like stone, wood blocks, etc.
- The radar sensor of parking assist system cannot detect vehicles with a high chassis.
- The parking radar system sensor cannot detect soft objects like snow, cotton, sponge which can absorb the ultrasonic wave.
- The radar sensor of parking assist system cannot detect some obstacles with special shapes, such as pillars, small trees, bicycles, angle materials, sills and corrugated paper.

Situation in which wrong alarm may be given

- There is ice on the sensor surface of the parking radar system.
- The vehicle is on a steep slope.
- The vehicle is fitted with high-frequency radio equipment or antenna or they are used nearby.
- The horn sound of other vehicles is too close to the parking radar system sensor.
- Driving in snow or rain.
- The license plate is not installed close to the surface of the license plate bottom bracket.

If the vehicle approaches an obstacle, the system still does not give alarm. Please contact Geely Service for maintenance as soon as possible when you confirm it is not caused by the above problems.

 When there are multiple obstacles, the sensor of parking radar system can only detect the nearest obstacle. Please note whether the parking sensor of another side detects other barrier when vehicle moves. ◀

 Do not directly spray or impact the sensor surface of the parking radar system with high-pressure water, such as a water gun, or else it may cause failure. ◀

Reversing visual system

The reversing visual system assists the driver to reverse by displaying the image behind the vehicle.

 The driver must carefully observe whether there are obstacles around the vehicle before backing up, otherwise it may cause casualties and property losses.

The reversing visual system cannot replace the driver's vision. Do not rely only on the reversing visual system to reverse.

- The distance displayed on the multimedia display screen is different from the actual distance.
- The reversing camera cannot detect objects outside the visual range of the camera, such as under the bumper or the vehicle.
- The reversing camera may not detect children, pedestrians, cyclists or pets.
- Do not use the reversing visual system in long-distance and fast reversing operations or in places where there are transverse passing vehicles. ◀

Position of rearview camera

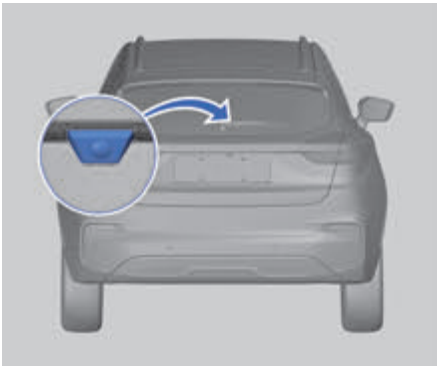

The rearview camera is located on the trunk door. The rearview camera has a limited view range and cannot detect the items in corners or below the bumper. Displayed images will be different as the vehicle direction or road condition varies. Distance in the image on the screen is different from the actual distance.

Guiding line for reversing

The guiding line for reversing is a dynamic track line, which adjusts the indicated direction according to the angle change of steering wheel rotation. In reversing, the guiding line for reversing covers the road behind the vehicle and turns left and right according to the rotation of the steering wheel. The direction indicated by the guiding line for reversing is the same as the actual running track of the vehicle, helping the driver plan the reversing route.

- Click the track line button to control the enabling/disabling of the track line function.
- The track line is turned on and the key is highlighted. The trace line is closed, and the key state is operable (not highlighted).

Turn on/off the system

When the vehicle is in the reverse gear (R), it can enter the reverse image interface.

- When the vehicle is placed in the reverse gear (R), the reversing visual system will be turned on, and the image will be automatically displayed on the multimedia display screen.
- When the vehicle is moved out of the reverse gear (R), the reversing visual system will be closed, and the multimedia display screen will switch back to the previously displayed interface.

Reversing camera connection interrupted

When the connection of the reversing camera is interrupted, a prompt box will pop

1

2

3

4

5

6

7

8

up on the multimedia display screen to prompt that the reversing camera is not connected properly. Contact Geely Service timely for maintenance.

Panoramic image system*

It enables the driver to monitor the front, rear, left and right video images outside the vehicle in real time by displaying the images collected by the camera on the multimedia display screen, so as to assist the driver in parking.



- When using the panoramic image system, pay attention to the surrounding conditions of the vehicle. The system can only be used as an auxiliary means for the vehicle. Do not rely only on the panoramic image system.
- Panoramic camera is vulnerable to environmental factors, such as fog, rain and snow, night and other low visibility environments. In such environments, the panoramic camera system should be used carefully to ensure the safety of the surrounding environment before use.
- The panoramic image system has a blind area and may not be able to detect all obstacles around the vehicle. ◀



This vehicle is equipped with a wide-angle fish-eye cameras, and the imaging model is bowl-shaped, resulting in the stretching deformation of 3D images at the splices, and overlapping of objects at the far end of the edge. ◀

Panoramic image camera

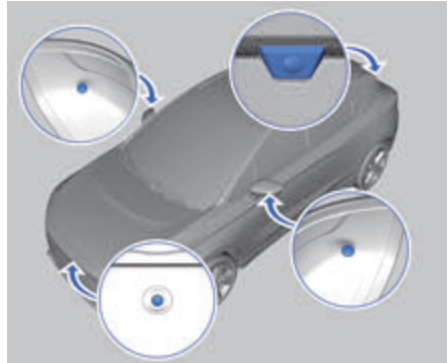

The panoramic image cameras are located around the vehicle body.

Enter the panoramic image interface

- If the steering linkage function has been enabled in the panoramic image setting interface, turn on the steering lamp when the gear is not in the R gear.
- Touch the 360 panoramic soft button on multimedia display.
- Engage the R gear to automatically enter the panoramic image system.
- In the panorama image setting interface, turn on the radar to activate the panorama function (some models), and the gear is in the D gear. When the radar at the front of the vehicle detects that the distance between the obstacles in front of the vehicle (including the front side) and the vehicle decreases from more than 30 cm to less than or equal to 30 cm, the panorama image system function is triggered to turn on.



Only when the vehicle speed is less than 30 km/h, will it enter the

panoramic image interface in the way above. ◀

Exit the panoramic image interface

- Touch the "return" button of panoramic image interface on multimedia display.
- Switch from the gear R, gear N and gear D to the gear P without any operation within 5 seconds, and exit the panoramic image.
- When the gear is not R, the panoramic image will exit when the vehicle speed exceeds the specified speed.
- If the panoramic image is turned on via turn signal lamp, and the view of panoramic image is not toggled by other operations (excluding the toggle of left/right turn signal lamp), when the turn signal lamp is turned off, the panoramic image automatically exits.

Setting interface

The driver can tap the specific area of the screen to show different pictures as demand.

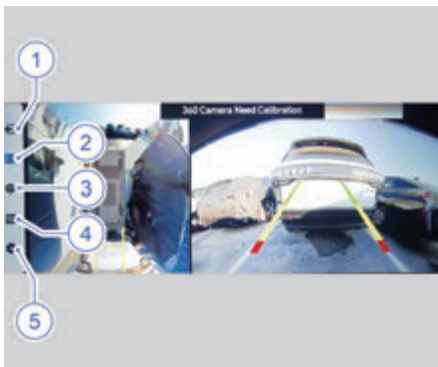

1. Exit
Exit the Panoramic Image Interface

2. Parking guiding lines

Touch this button to turn on/off the parking guiding lines. The button operation state is memorized when the system is activated next time.

3. 2D/3D view effect

Switch to 2D/3D view effect.

4. Perspective mode

Open the perspective selection menu to select more perspectives.

5. Settings

3D surround, vehicle transparency, steering linkage, radar alarm stereo display, radar alarm sound, radar activation panorama and color selection can be set.

 In addition to function buttons above, directly touch camera icons around the panoramic image vehicle model to quickly change the viewpoints of images. ◀

1

2

3

4

5

6

7

8

Vehicle charging

Charging precautions



The following items must be observed to avoid high-voltage electric shock or more serious injury:

- Check the charging cable before charging, and do not use the charging cable with damaged skin or shell.
- Before charging, make sure that there is no water or peculiar matter in the charging port of the vehicle, power supply equipment and charging connection device, and that the metal terminals are free of rust or corrosion.
- Do not disassemble or modify the charging device and related ports without permission.
- Choose a dry, ventilated and safe environment for charging, avoid rain, water immersion, and do not use the charging device in an environment where there are fire sources and flammable and explosive materials.
- Do not allow children to charge.
- Do not touch the charging port.
- In case of sudden weather changes (strong wind, rain, snow, and thunderstorm) during charging, check whether the charging plug is firm and dry in time. In case of thunder and lightning, do not touch the charging cable or the vehicle.
- If there is moisture near the charging port during the charging process, please disconnect the power supply first, then disconnect the plug at the power supply end (do not touch the metal sheet of the

charging plug with your hands or other parts of your body to avoid safety accidents), and then pull out the charger. If necessary, please use insulating gloves and contact Geely Service for inspection and confirmation as soon as possible.

- If the vehicle emits peculiar smell during charging, stop charging immediately.
- Do not squeeze the charging cable when charging.
- After charging, do not disconnect the charging connection device when your hands are wet or standing in the ground water.
- Before driving, make sure that the charging connection device is disconnected from the vehicle charging port. ◀

Charging operation



Use DC fast charging devices that meet the standard, otherwise they may cause fault or fire and cause casualties. ◀



The charging must be carried out or stopped in strict accordance with the operation process of the DC fast charging pile. It is prohibited to plug or unplug the DC fast charging plug at will during the charging process. ◀

AC charging of wall mounted AC charging pile





When the ambient temperature is too high/low, the charging time of the vehicle will be extended, which is normal. The charging system automatically adjusts the charging time to ensure the best

performance of the power battery as the temperature changes. ◀

Operating steps

Insert the charger into the AC charging interface of the vehicle, press the charging start button, and charge automatically after swiping the card.

 For the operation method of wall mounted AC charging pile, see the user manual attached to the charging pile. ◀

 Plug and pull the AC slow charging plug vertically as carefully as possible to prevent damage to the vehicle or charging equipment. ◀

Energy center



Click on the multimedia display screen in sequence: homepage → energy center → energy display. The energy status can be viewed in this interface.

AC slow charging of charging station

Operating steps

1. Stop the vehicle stably and switch the gear to the parking gear (P);

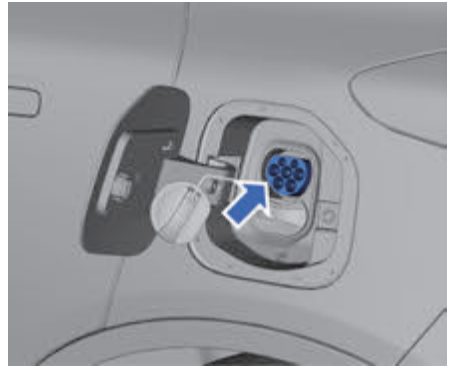

2. Unlock the vehicle, press the charging port cover, the charging port cover pops up, and take out the protective cover of the AC charging interface;
3. Remove the special AC charger for the charging pile from the charging pile;

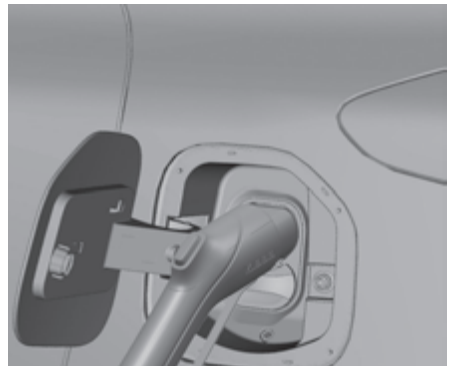

4. Press the button on the AC charger, and insert the charger into the AC charging interface of the vehicle body;

1

2

3

4

5

6

7

8



5. Follow the instructions of the charging pile to complete the charging.
6. After full charge or when it is necessary to end charging, the charging shall be ended according to the instructions of the charging pile;
7. Unlock the electronic lock of the charging socket, press the button on the charger and pull out the charger as soon as possible;
8. Close the protective cover of the AC charging interface and the charging port cover, and put the charger back to the original position of the charging pile.

DC fast charging of charging station

Operating steps

1. Stop the vehicle stably and switch the gear to the parking gear (P);
2. Unlock the vehicle, press the charging port cover, the charging port cover pops up, and take out the protective cover of the DC charging interface;
3. Remove the special DC charger for the charging pile from the charging pile;

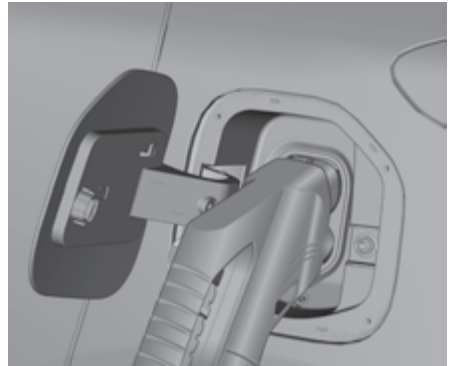

4. Press the button on the DC charger, and insert the charger into the DC charging interface of the vehicle body;



5. Follow the instructions of the charging pile to complete the charging;
6. After full charge or when it is necessary to end charging, the charging shall be ended according to the instructions of the charging pile;
7. Unlock the electronic lock of the charging socket, press the button on the charger and pull out the charger as soon as possible;
8. Close the protective cover of the DC charging interface and the charging port

cover, and put the charger back to the original position of the charging pile.

Electronic lock

Locking

Insert the charger and lock it automatically when the charging conditions are met.

Unlocking

There are two ways to unlock:

1. When the vehicle power supply is in the OFF gear, press the smart key unlock key or the central control unlock key to unlock.
2. When the key unlocking fails, it can be unlocked through the emergency charging port cable.

 After pressing the smart key unlock button, if the charger is not pulled out within 30 seconds and no smart key button is operated, the electronic lock will automatically lock and continue charging. ◀

1

2

3

4

5

6

7

8

Emergency equipment

Hazard warning lamp



Under special circumstances when the vehicle needs to be decelerated or stopped in an emergency, press the hazard warning lamp switch. Then the indicator on the switch flashes along with the left and right turn signal indicators to warn others.

Reflective vest

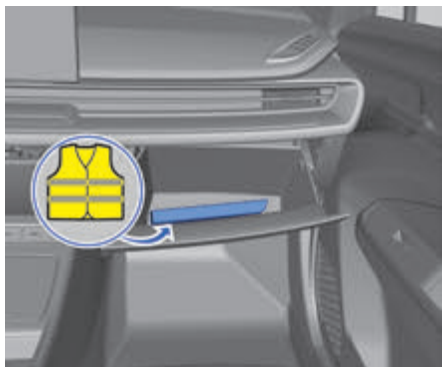

The reflective vest is placed in the glove box, which can be seen when you open it.

 In case of an emergency, the driver should wear a reflective vest before getting out of the vehicle to ensure personal safety. ◀

Warning triangle



The warning triangle is placed in the storage box under the boot and can be seen by pulling open the boot.

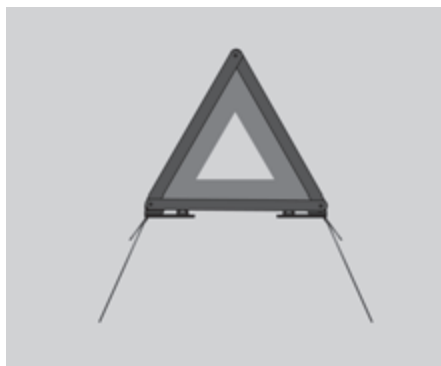

On the normal road, the warning triangle shall be placed 50 m -100 m away behind the vehicle. On the expressway, alarming label shall be placed 150 m away behind the vehicle. In rainy or foggy weather, the distance shall be 200 m.

1

2

3

4

5

6

7

8

First aid kit



The first aid kit is stored in the trunk and can be seen by opening the trunk.

The first aid kit contains medical gauze, elastic bandage, breathable tape, band aid, safety scissors, tire pressure gauge and other items.

Insert the tire pressure gauge into the tire valve, and the tire pressure value is displayed at the rear of the tire pressure gauge.

 The first aid kit can be used to stop bleeding in an emergency, please seek medical attention as soon as possible. In an emergency, please contact emergency personnel for treatment immediately. ◀

Fire extinguisher



Place the fire extinguisher in the trunk.

 In case of an emergency, please ensure your own safety first, organize fire fighting, and contact the fire department.



Emergency unlocking

Emergency unlocking door

Lock and unlock with the mechanical key

 When the smart key or the vehicle is powered off, the mechanical key can be used to unlock or lock the door. ◀

Driver's door

1. Take out the mechanical key from the smart key;

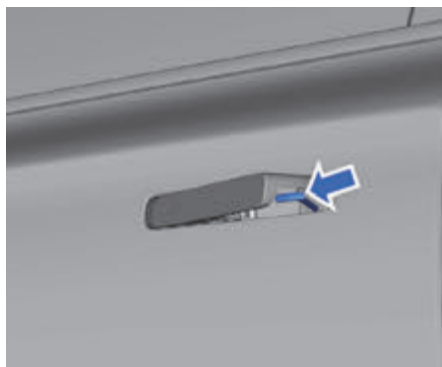

2. Insert the mechanical key into the door lock on the driver's side. Rotate counterclockwise to unlock the door. Rotate clockwise to lock the door.

Occupant's side door and rear door



1. Take out the mechanical key from the smart key;
2. Insert the mechanical key into the white knob at the fish mouth of the door lock for rotation;
3. Take out the mechanical key and close the door to lock it completely.

Emergency unlocking trunk door

1. Fully fold the rear seat backrest;
2. Enter the trunk directly from the rear seat, and find the cover plate of the emergency opening device of the trunk door on the interior trim panel of the trunk door;

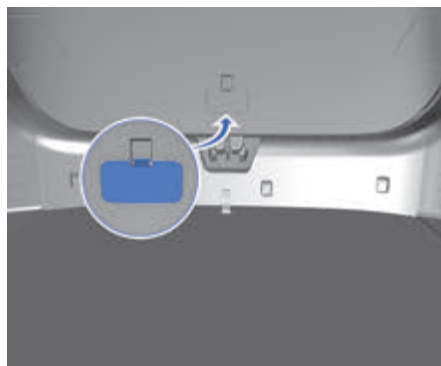

1

2

3

4

5

6

7

8

3. Buckle the cover of trunk emergency opening device;

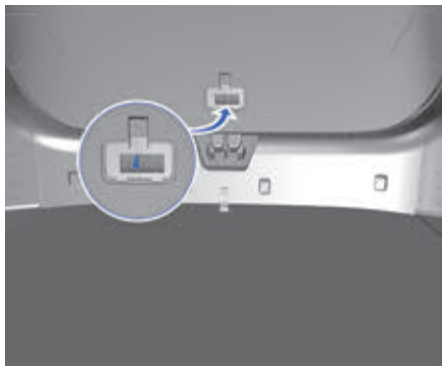

4. Turn the trunk emergency opening switch to the right to open the trunk door.

Emergency unlocking charger



If the charger cannot be pulled out, it can be unlocked according to the following steps:

1. Open the trunk door;
2. Remove the black baffle;
3. Pull the cable of the emergency charging port on the left side of the trunk to unlock the charger.

 If the charger still cannot be unplugged, stop charging immediately

and contact Geely Service for maintenance.



Replace the key battery

Replace the key battery

Replacement of smart key battery

Battery in the smart key should be replaced when the remote control distance of smart key is very short, unable to remotely control the vehicle, or vehicle cannot recognize the smart key due to low battery power.



1. Take out the mechanical key, insert the mechanical key into the side opening at the rear end of the key, and then hold the handle to pry open the back cover of the key;



2. Replace the battery with a new one. Note that the anode of the battery is facing the rear cover (logo side). Smart key battery model: 3V, CR2032;
3. Install the smart key chip on the back cover (logo side);
4. Clip the two halves of the smart key housing into place.



- Keep the battery out of children's reach to prevent children from swallowing the replaced battery by mistake.
- If the key cannot be used after replacing the battery, please contact Geely Service for maintenance. ◀



- Dispose of waste batteries according to local regulations to avoid damaging the environment. ◀

1

2

3

4

5

6

7

8

Jumper starting

Jumper starting

 If the vehicle cannot be started due to a lack of battery power, another vehicle jumper cable can be used to start the vehicle.

Failure to operate strictly in accordance with the following steps may cause injuries. ◀

 Do not start the vehicle by pushing or pulling.

Use only batteries rated at 12 volts for jumper starting. ◀

1. Switch the vehicle power supply to the OFF gear, and turn off all lights and electrical accessories of the vehicle except for the hazard warning lamp (if necessary);
2. Connect the auxiliary cables in the following order;

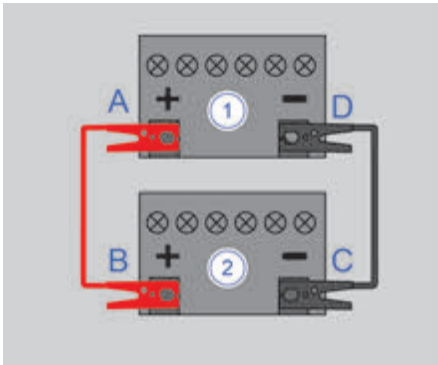

A: Battery anode of vehicle with power loss

B: Battery anode of rescue vehicle

C: Battery cathode of rescue vehicle

D: Battery cathode of vehicle with power loss

3. Charging the battery;

Start the rescue vehicle for about 5 minutes to temporarily charge the battery of the vehicle with power loss.

4. Start the vehicle with power loss; Start the vehicle with power loss. If the vehicle still cannot be started, confirm whether the jumper cable connection is normal, and then charge the battery.
5. Remove the jumper cable. After starting the vehicle, remove the battery cathode (D) and black jumper cable of the vehicle. Then remove the battery anode (A) and the red jumper cable of the vehicle with power loss.



- Be careful not to touch the high temperature area of the front engine compartment.
- Gas may escape from the battery during charging or jumper starting. There is a risk of explosion. Keep the battery away from sparks, open flames and other flammable substances.
- Using open fire near the battery is possible to cause explosion of the gases in battery, resulting personal injury or death. The electrolyte of the battery is corrosive and easy to cause serious damage to eyes and skin. In case of accidental contact, immediately flush with plenty of water and seek medical advice.
- When connecting and removing jumper cables, do not wind the cables and fans together.
- Ensure that all cables are correctly connected, and keep a certain distance

between each end to avoid positive and negative contact. If the above steps are not followed, the repair is not covered by the warranty.

- If the vehicle still cannot be started after several jumper attempts, or the battery is often out of power, contact Geely Service for maintenance. ◀

Vehicle towing

Towing tips

This vehicle is a pure electric vehicle with front wheel drive. You can choose the following two ways to tow the vehicle:

1. Flat panel device: load the vehicle to be towed onto the truck.
2. Wheel lifting device: the trailer crane inserts two arms into the bottom of the front wheel of the vehicle to lift the wheel off the ground, while the rear wheel is still on the ground.



- If the vehicle cannot be towed by the flat plate device, the wheel lifting device shall be used to tow the front wheel.
- Both the towed crane and the towed vehicle shall turn on the hazard warning lights. ◀

Towing eye

Precautions for using the towing eye

- Ensure that the towing eye is screwed firmly and reliably into the mounting hole.
- It is recommended to mount and use the approved traction rod or traction rope on the towing eye.
- Do not use the towing eye to tow the vehicle to the flat rescue vehicle.
- Do not use the towing eye to rescue a trapped vehicle.



When towing with the tow eye, make sure to keep a safe distance from the vehicle.

1

2

3

4

5

6

7

8

- Do not use the towing chain/belt on the towing ring. The towing chain/belt may be broken, resulting in serious injury or death.
- Failure to follow proper tow eye instructions may lead to component breakage, resulting in serious injury or death. ◀

 The towing eye is only used for road rescue and shall not be used for other purposes.

- When using the towing eye, be sure to use the appropriate equipment that complies with traffic regulations (such as a rigid tow bar or tow rope), so as to tow the vehicle to the nearest maintenance point on the ground for a short distance.
- It is not allowed to use the towing eye to tow the vehicle on the off highway or the road with obstacles.
- When towing with a towing eye, both the towing vehicle and the towed vehicle must be on the same centerline as far as possible. Failure to follow the above instructions may result in damage to the vehicle. ◀

Installing front towing eye

1. Take out the towing eye in the attached tool box in the trunk;
2. Press to open the right front trailer hitch cover plate located on the front bumper;

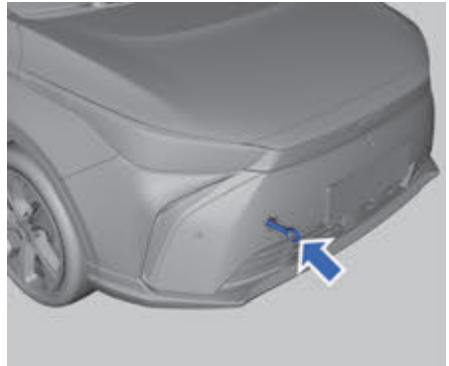

3. Screw the towing eye into the mounting hole and tighten it with the wheel nut wrench to ensure that the towing eye is fully tightened.

Replacement of spare tire

Replacement of spare tire

 Park the vehicle on a level surface that does not interfere with traffic and is convenient for safe wheel replacement. Before replacing wheels in an emergency, turn on the vehicle's hazard warning lamps and place the warning triangles on the road at a suitable distance according to road conditions to avoid traffic accidents. ◀

Taking out the spare tire and tool kit

Jack and other on-board tools

The jack and tool kit are placed in the boot.

 Please use the special jack provided with the vehicle. It is prohibited to use other non-compliant jacks; otherwise, the vehicle may slide down due to the quality of the jack, resulting in personal injury or death. ◀

Spare tire

Type I



1. Lock knob

The spare tire is stored under the floor mats in the trunk.

After removing the floor mat, take out the vehicle tool box, turn the lock knob counterclockwise, take out the audio device attached to the spare tire wheel well, and then take down the spare tire.

Type II



1. Lock knob

The spare tire is stored under the floor mats in the trunk.

After removing the floor mat, take out the accompanying tools kit, and rotate the locking knob counterclockwise to remove the spare tire.

 The spare tire of the vehicle is a T-type small spare tire. When using, the maximum speed is 80 km/h. please drive the vehicle to Geely Automobile Service as soon as possible to replace with a new tire. ◀

Remove flat tire and mount spare tire

1. Carry out safety inspection before the operation;

1

2

3

4

5

6

7

8



2. Take out the plastic pliers from the vehicle tool box, clamp the wheel nut trim cap with the plastic pliers as shown in the figure, and pull the trim cap outward;



3. Put the wheel wrench on the wheel nut and turn it counterclockwise to loosen all the wheel nuts for about one turn, but do not remove the wheel nuts first;

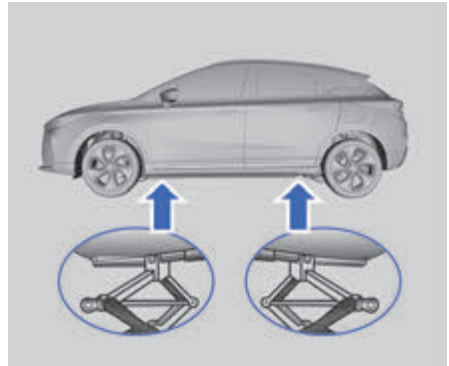

4. Place the jack head. Adjust the jack to a suitable height as shown in the figure, and then place the jack under the lifting point;

 The vehicle will be damaged and even may roll over if the supporting position of the jack is incorrect when the vehicle is lifted. To avoid personal injury and vehicle damages, before lifting the vehicle, be sure to place the jack head at the correct position. ◀

 The vehicle is equipped with a jack, which can only be used to replace a flat tire. Do not come below the vehicle merely supported by lifting jack. If the vehicle slips off the jack, serious personal injury or death may result. ◀

5. Connect the jack handle;

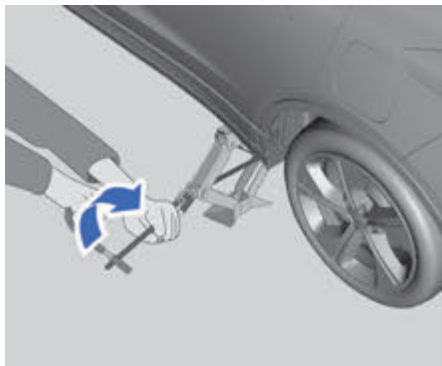

6. Turn the jack handle clockwise as shown in the figure to lift the vehicle to a sufficient height above the ground to install the spare tire;
7. Remove all wheel nuts;
8. Remove the flat tire;
9. Remove rust or dirt on wheel bolts, mounting surface and spare wheel;

 Rust or dirt on wheel or connecting position of wheel will make wheel nuts become loose after being used for certain time. Wheels may fall off and result in accident. Before replacing the wheel, use a scraper or wire brush to remove any rust or dirt from the connection between the wheel and the vehicle. ◀

10. Mount a spare tire;
11. Screw each nut clockwise with a wheel wrench until the wheel is fixed on the hub;
12. Turn handle of the jack counterclockwise to lower the vehicle. Lower the jack completely;

 Do not use grease on the bolts or wheel nuts, otherwise the wheel nuts

will become loose and the wheels of the vehicle may fall off, causing accidents. ◀



13. Pre-tighten the wheel nuts in a cross sequence as shown in the figure;
14. Lower the jack to the bottom, and take out the jack from below the vehicle;
15. Tighten the wheel nuts with the wheel wrench;
16. Install the wheel nut trim cap;
17. If necessary, install the hub trim cover.

 If the front tire fails, and a spare tire needs to be used, please be sure not to replace the front tire with the spare tire. For driving safety, please replace the faulty front tire with a normal rear tire, and then install the spare tire to the removed rear tire position. ◀

Storing the spare tire and tool kit

Place the spare tire with the inner side facing up in the spare tire compartment of the trunk, place the audio device, screw in the lock knob and fully tighten it. Put the jack and other tools back into the driver's tool kit, then place the kit in the boot and secure it properly.

1

2

3

4

5

6

7

8

Replacement of fuse

Inspection or replacement of fuse

If any electrical components do not work, the fuse may have blown. If this happens, it is recommended to check as follows and replace the fuse if necessary.

1. Turn off the vehicle power supply and all electrical equipment, and disconnect the negative battery cable.

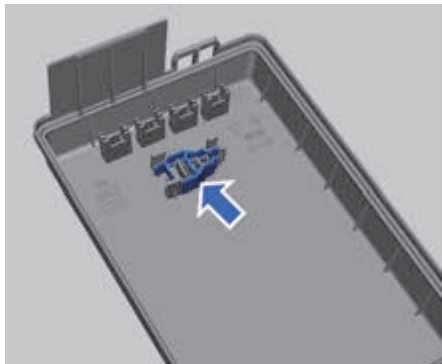

2. Clamp the fuse head with the fuse clip and remove the fuse. Check whether the wire is blown.

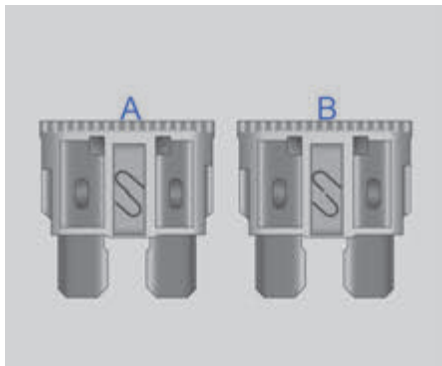



A - Fuse is in good condition

B - Fuse is blown

 For the blown fuse, do not attempt to repair it or replace it with a fuse with different color or ampere value, otherwise the electrical system will be damaged or a fire will occur due to overloading of wires. ◀

3. Replace with a new fuse of the same model. If the fuse blows immediately after replacement, please contact Geely Service for maintenance as soon as possible.

 The fuse color represents the amperage of the fuse, which is also marked on the fuse. ◀

 All electrical components on the vehicle may be damaged if splashed with liquid. Be sure to secure the covers of all electrical parts and components. ◀

Front engine compartment fuse box

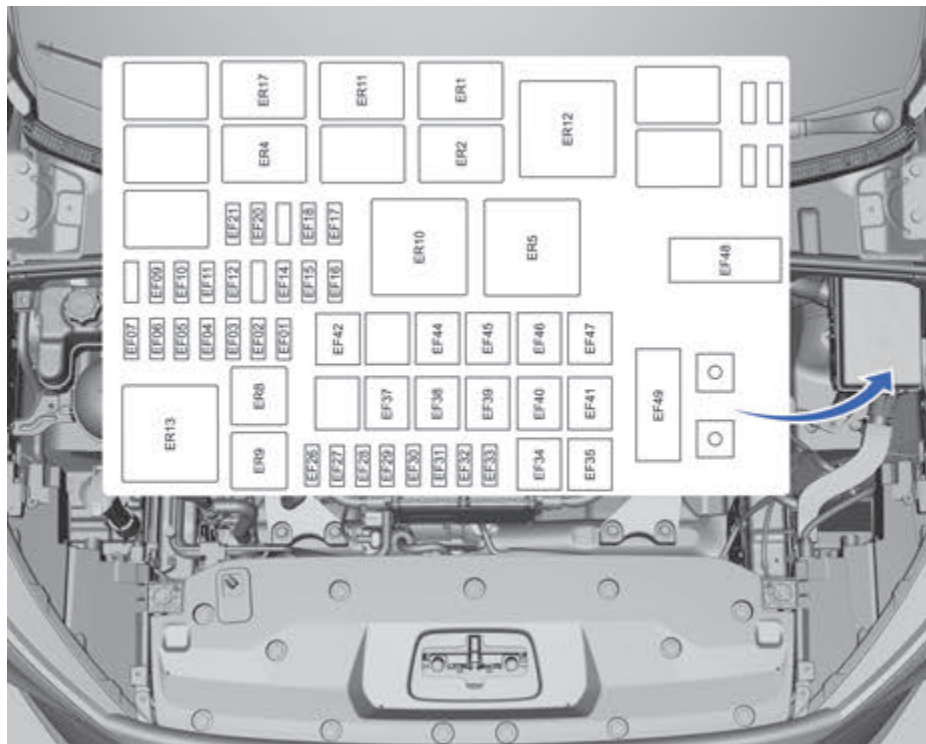

Fuse No.	Name	Ampere value	Description
EF01	Brake lamp switch fuse	7.5A	-
EF02	Vehicle control unit fuse	10A	-
EF03	Integrated power controller fuse	15A	-
EF04	Battery management system/charger fuse	15A	-
EF05	Turn signals power supply fuse	30A	-
EF06	Turn signal lamp/front middle position lamp fuse	10A	-
EF07	Horn fuse	15A	-
EF09	PWM fan relay feedback fuse*	10A	-

Fuse No.	Name	Ampere value	Description
EF10	Cooling water pump relay feedback fuse	7.5A	-
EF11	High-speed fan relay feedback fuse*	5A	-
EF12	Low-speed fan relay feedback fuse*	5A	-
EF14	Fan and cooling water pump relay control fuse*	10A	-
EF15	Vehicle control unit fuse	20A	-
EF16	Brake switch fuse	5A	-
EF17	Electronic stability control unit/vehicle controller fuse	7.5A	-
EF18	Integrated power controller/charger fuse	7.5A	-
EF20	Low-speed alarm/gateway fuse	7.5A	-
EF21	Rear view mirror heating fuse	10A	-
EF26	A/C relay fuse	15A	-
EF27	Air intake grille fuse*	7.5A	-
EF28	Front wiper fuse	30A	-
EF29	Compressor fuse	7.5A	-
EF30	Charging indicator fuse*	5A	-
EF31	Refrigerant water pump fuse	15A	-
EF32	Power amplifier fuse	30A	-
EF33	Gateway fuse	10A	-
EF34	Rear defroster fuse	25A	-
EF35	PWM /low-speed fan fuse*	30A	-
EF37	Occupant's seat fuse*	25A	-
EF38	Blower fuse	40A	-
EF39	IG2 power supply fuse	25A	-
EF40	Driver's seat fuse*	25A	-
EF41	Left window fuse (for four-door, anti-pinch model)	25A	Type I

Fuse No.	Name	Ampere value	Description
	Ripple anti-pinch 2 fuse(for ripple, anti-pinch model)	30A	Type II
EF42	Instrument fuse box fuse	60A	-
EF44	High-speed fan fuse*	40A	-
EF45	Electronic stability control (ESC) unit motor system	60A	-
EF46	Electronic stability control (ESC) unit fuse	40A	-
EF47	Instrument fuse box fuse	50A	-
EF48	Electric Power Steering (EPS) fuse	80A	-
EF49	Charger fuse	150A	-

1

2

3

4

5

6

7

8

Interior fuse box

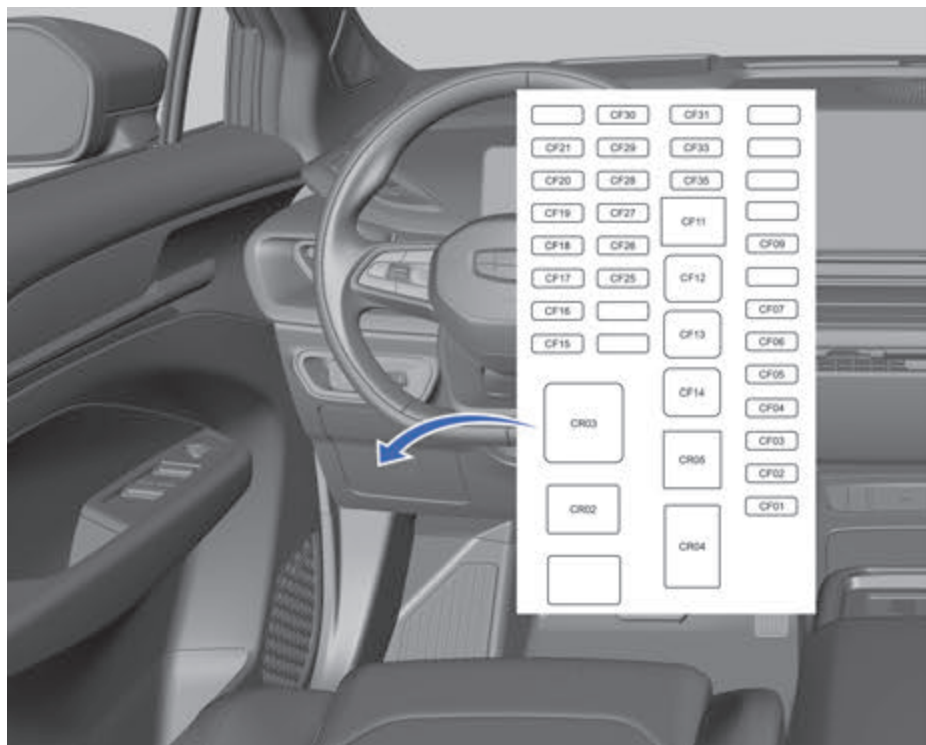

Fuse No.	Name	Ampere value	Description
CF01	Fuse of exterior lamp power supply 1	30A	–
CF02	Fuse of exterior lamp power supply 2	30A	–
CF03	Diagnostic port fuse	10A	–
CF04	Central control unit (CCU) fuse	30A	–
CF05	Door lock fuse	30A	–
CF06	Panoramic image & dashboard camera & heads up display&RF receiver module & wireless charging & charger controller & angle radar fuse*	10A	–
CF07	Electronic shifter & combination switch & rearview adjustment switch & combination switch fuse	10A	–

Fuse No.	Name	Ampere value	Description
CF09	Central control screen & driver monitoring module fuse*	10A	-
CF11	Marine fuse	25A	-
CF12	Electronic door handle fuse*	20A	-
CF13	Sunshade fuse*	20A	-
CF14	Window 2 fuse	25A	Type I
	Ripple anti-pinch 2 fuse	30A	Type II
CF15	Central controller IG2 feedback & battery management system IG2 fuse	10A	-
CF16	Rear wiper fuse	15A	-
CF17	Washer motor fuse	15A	-
CF18	Backup power supply fuse	20A	-
CF19	Central controller & panoramic image&ACC fuse*	10A	-
CF20	Dashboard camera & entertainment vehicle & A/C control module & in-vehicle intelligent monitoring system&drive mode switch fuse*	10A	-
CF21	USB fuse	15A	-
CF25	Seat module & driver seat & sunshade module*charger controller * electronic toll system * front monocular camera fuse*	10A	-
CF26	Central controller * on-board terminal & combination switch & emergency rescue system fuse*	10A	-
CF27	Front motor compartment IG1 fuse	15A	-
CF28	Fuse for steering wheel angle sensor/electric power steering/electronic gear shifter	10A	-
CF29	Airbag fuse	10A	-

Fuse No.	Name	Ampere value	Description
CF30	Aroma system & air quality control system & PM2.5 & radar & electronic parking brake fuse*	10A	-
CF31	Atmosphere lamp fuse*	5A	-
CF33	A/C control module & instrument cluster & on-board terminal & emergency rescue system fuse *	10A	-
CF35	Entertainment hose fuse	15A	-

Replacement of bulb

Replacement of bulb

Bulb specifications

Part name	Bulb name	Bulb model	Power
Trunk lamp	Trunk lamp	W5W	5W



The bulb model of other parts is LED. ◀



When there is a temperature difference between the inside and outside of the lamp shade of the front combination lamp, such as in rainy days or when washing the car, there may be temporary fogging in the lamp shade. This is natural. The fog will dissipate after the lights are turned on for a short time. If it does not dissipate, contact Geely Service for inspection and repair. ◀

1

2

3

4

5

6

7

8

Emergency handling

Drive motor or motor controller overheating

Overheating of the vehicle actually means that the coolant temperature is too high. If the motor and controller overheating warning lights on the combination instrument are lit, it means that the drive motor is overheating. The following procedures should be followed:

1. Drive the vehicle safely away from the road to a safe place, then stop the vehicle and turn on the hazard warning lamp, set the reducer to the parking gear (P), and press the EPB switch. Turn off the air conditioner if it is working.
2. Visually inspect the radiator, hoses, and underside of the vehicle for obvious coolant leaks. If there is, it is normal that there are water drops coming from the working air conditioner.
3. If the coolant leaks, stop using the vehicle immediately, and contact Geely Service for maintenance as soon as possible.
4. If there is no obvious water leakage, check the coolant expansion tank. If it is dry, add about half of the coolant to the coolant expansion tank when the vehicle is started.
5. If there is no coolant leakage and the coolant level in the expansion tank is normal, please contact Geely Service for maintenance as soon as possible.
6. After the coolant temperature drops to normal, check the coolant level in the coolant expansion tank again. Fill to the

half of the volume if necessary. Serious loss of engine coolant indicates that there is leakage in the system. Please contact Geely Service for maintenance as soon as possible.

7. After shutdown in summer, the cooling fan often operates automatically or even does not stop for a long time, which is normal. When the temperature of the drive motor or motor controller decreases to the operating temperature of the fan without cooling, the cooling fan automatically turns off.



In order to avoid personal injury, the front compartment hood shall be closed till there is no vapor. The outflow of vapor or coolant indicates a high pressure. Keep personnel away from rotating cooling fans. ◀

Vehicle fire

In case of fire, stop the vehicle immediately and then shut down the vehicle, evacuate passengers from the vehicle quickly and call the police. If it is possible to ensure personal safety, contact Geely Service and carry out the following operations under the guidance of professionals:

1. If the power battery harness smokes and catches fire, use a carbon dioxide or dry powder extinguisher to spray.
2. If the power battery catches fire, use a high-pressure water gun to extinguish the fire at a distance.
3. If you inhale thick smoke accidentally, please see a doctor as soon as possible.



- The leakage or damage of the power battery electrolyte may cause a fire. If this happens, please immediately contact Geely Service for repair.
- Do not touch the leaking electrolyte with your hands. If the skin or eyes accidentally contact with the electrolyte, rinse with plenty of water and seek medical advice immediately.
- If the vehicle is on fire, leave it immediately. ◀

Getting vehicle out of trap

When the vehicle is stuck in snow, mud puddles, sand or other soft roads, please refer to the following steps to get rid of the status quo.

1. Observe the front and rear areas of the vehicle to ensure that there are no people or obstacles.
2. Turn the steering wheel left and right to grind out an area around the front wheel.
3. Engage the drive gear or reverse gear to make the vehicle move forward and backward slowly.
4. If not get out of the dilemma after many attempts, seek professional trailer service.



When using forward and backward movement to drive the vehicle out of the pit, it may suddenly rush forward or backward. The driver must keep alert at all times to avoid casualties. ◀

Emergency response to road accidents*

The system monitors the airbag burst signal and the user's manual call operation through the built-in controller of the vehicle, and sends the location, vehicle travel direction, vehicle data, etc. when the vehicle collision accident occurs to the background seats through the network to obtain the rescue service of the public service center. Triggering conditions of road accident emergency response system:

1. The controller detects the airbag explosion signal
2. Press and hold the SOS switch

When any of the above conditions is triggered, the system will send the information to the public service center after startup, and at the same time, make an emergency call. The control center confirms the accident information and requests rescue service from the public service center, and ends the call after confirming the relevant information.



1. SOS switch
2. SOS indicator

1

2

3

4

5

6

7

8

When the emergency call system needs to be started, you can directly press the SOS switch of the front indoor lighting lamp. The SOS indicator will indicate the system status and call status accordingly. When the system is working normally, users can make voice calls.

Maintenance instruction

Regular maintenance

It is recommended to pay attention to the vehicle status regularly to keep your car in the best condition.

Door stop

The door stop needs to be smeared with grease regularly, otherwise the door may make abnormal noise when opening and closing.

Maintenance of sunroof glass*

Use glass cleaner to clean the glass panel of sunroof. Do not use viscous cleaners!

Oils and fluids

Open and close the front engine hood

Open the front engine hood



1. Pull the open handle of the front engine hood at the lower left of the dashboard on the driver's side for two consecutive times;

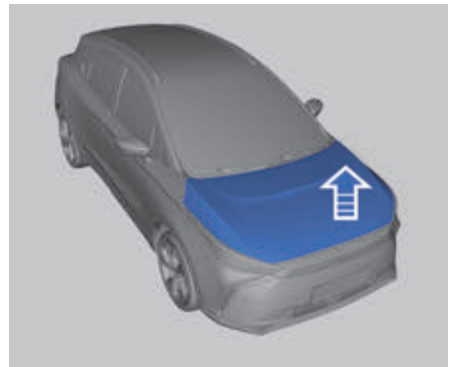

2. Lift the front engine hood;
3. Lift the front engine hood support rod to support the front engine hood.

Close the front engine hood

-  Before closing the front engine hood, check whether there are relevant

1

2

3

4

5

6

7

8

tools, rags, etc. left in the engine room, and ensure that all filler caps have been covered. ◀

1. Close the front engine hood downward and hear a click, indicating that the front engine hood is locked;
2. After closing the front engine hood, verify that it is fully locked by trying to lift the front edge of it.

If it is not completely locked, it is necessary to re open the front engine hood, and then close the front engine hood. It is not allowed to close the front engine hood by direct force.



It is prohibited to drive when the front engine hood is not closed correctly. ◀

Coolant

Drive motor coolant filling



Be sure to park the vehicle on flat ground when inspecting engine coolant level. Check that the coolant level in the coolant expansion tank is between MAX and MIN marks. If the coolant level is lower than the MIN mark, fill the coolant expansion tank with coolant according to the specified procedure.

The pressure cap of the coolant expansion tank must not be opened until the cooling system (including the pressure cap of the coolant expansion tank and the upper radiator hose) is completely cooled.



1. Turn the pressure cap counterclockwise slowly. If you hear any “fizz” sound, open it after “fizz” sound disappears. Fizz means there is still pressure inside;
2. Continue to turn the pressure cap and remove it;
3. Slowly fill the coolant until the coolant volume in the expansion tank reaches between MAX and MIN, and the liquid level does not drop;
4. Start the vehicle, keep the vehicle stationary, turn on the air conditioning system, and exhaust the residual air in the system through the operation of the electric water pump; Squeeze the radiator outlet hose to speed up the evacuation;
5. If the coolant in the coolant expansion tank drops, replenish the coolant in time. The coolant level in the coolant expansion tank should be kept between MAX line and MIN marks;

- Observe the vent of the coolant expansion tank. When there is continuous coolant flowing out from the vent of the coolant expansion tank and the coolant level in the coolant expansion tank does not drop anymore, tighten the pressure cap of the coolant expansion tank until the coolant is filled.

 If the ethylene glycol type coolant certified by Geely is filled, the damage or fault caused by using inferior coolant or unqualified coolant mixture is not covered by Geely's warranty. ◀

Power battery coolant filling



Be sure to park the vehicle on flat ground when inspecting engine coolant level. Check that the coolant level in the coolant expansion tank is between MAX and MIN marks. If the coolant level is lower than the MIN mark, fill the coolant expansion tank with coolant according to the specified procedure.

The pressure cap of the coolant expansion tank must not be opened until the cooling system (including the pressure cap of the coolant expansion tank and the upper radiator hose) is completely cooled.



- Turn the pressure cap counterclockwise slowly. If you hear any “fizz” sound, open it after “fizz” sound disappears. Fizz means there is still pressure inside;
- Continue to turn the pressure cap and remove it;
- Slowly fill the coolant until the coolant volume in the expansion tank reaches between MAX and MIN, and the liquid level does not drop;
- Start the vehicle, keep the vehicle stationary, turn on the air conditioning system, and exhaust the residual air in the system through the operation of the electric water pump; Squeeze the radiator outlet hose to speed up the evacuation;
- If the coolant in the coolant expansion tank drops, replenish the coolant in time. The coolant level in the coolant expansion tank should be kept between MAX line and MIN marks;
- Observe the vent of the coolant expansion tank. When there is continuous coolant flowing out from the vent of the coolant expansion tank and the coolant level in the coolant expansion tank does not drop anymore,

1

2

3

4

5

6

7

8

tighten the pressure cap of the coolant expansion tank until the coolant is filled.

 If the ethylene glycol type coolant certified by Geely is filled, the damage or fault caused by using inferior coolant or unqualified coolant mixture is not covered by Geely's warranty. ◀

Brake fluid

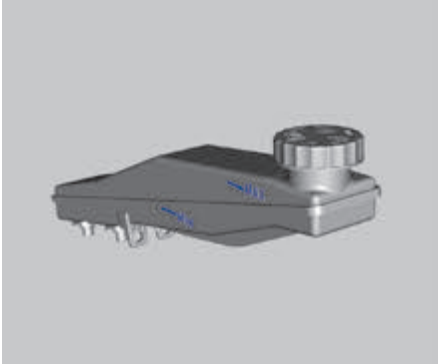

Please check the brake fluid level irregularly to ensure that the brake fluid level must always be between the MAX and MIN marks.

If the brake fluid level is lower than the MIN scale mark, unscrew the reservoir cap and slowly pour in the brake fluid to prevent the

brake fluid from overflowing. In case of accidental spillage, it shall be removed immediately, otherwise the parts in the engine room will be damaged.



- Brake fluid is harmful to human body. In case of accidental contact, wash immediately with plenty of water. If the brake fluid is taken by mistake, consult a doctor immediately.
- Brake fluid leakage causes the brake fluid level to drop. Go to Geely Service for maintenance as soon as possible.
- Use the brake fluid of the manufacturer and brand designated by Geely, otherwise it will seriously damage the parts of the brake hydraulic system and affect the braking performance and distance. ◀

Washer fluid

Topping up washer fluid

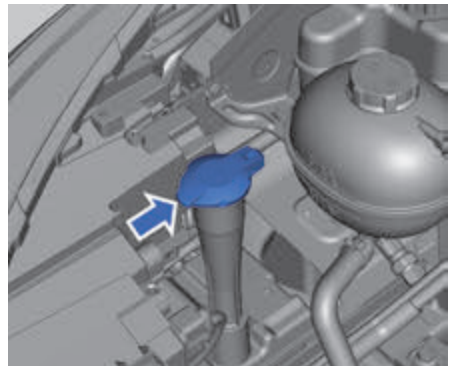

Open the filler cap with a washer sign printed on it, and add the appropriate amount of washer fluid.

 The freezing point temperature of the washer liquid should be 10° C lower than the local minimum temperature. ◀

Wiper blades

Replacement of wiper blade



- Grease, silicon and petroleum products will weaken the wiping effect of wiper blades. Wash wiper blades in warm soap water and check their conditions regularly.
- Wash windshield frequently, and avoid using wiper blade to wipe sands on windshield so as to avoid affecting wiping effect of wiper blades and reducing their service life.
- It is necessary to replace wiper blades if the rubber is found to be hardened or have cracks, or if wipers leave scratch on windshield glass or cannot reach a certain area.
- Clean windshield glass regularly with qualified glass liquid detergent, and ensure to clean windshield thoroughly before replacing wiper blades.
- Only use wiper blades of same specification as original wiper blades.
- If a wiper or a windshield is covered by ice or snow or is frozen, it is necessary to remove ice and snow on the wiper or the windshield before using the wiper, so as to prevent the wiper from being damaged.
- Do not use the wipers when a windshield surface is dry or there are hard objects on the surface; otherwise it is possible to damage wiper blades and windshield. ◀

1

2

3

4

5

6

7

8

Replacement of front windshield wiper blades

1. The vehicle is stationary, and after the power supply of the whole vehicle is switched to the OFF gear, the wiper switch position is switched from the OFF gear to low speed or intermittent brush gear and kept for about 2 seconds, and the function of wiper maintenance mode starts;

 The front wiper will return to its original position when the front wiper/front windshield is washed or the rain sensor is activated. ◀

2. Pull the windshield wiper blade away from the windshield;

 When the windshield wiper blade is upright, the front engine hood shall not be opened, otherwise the windshield wiper blade or the front engine hood will be damaged. ◀



3. While pressing the clip of the wiper blade, pull the wiper blade in the direction of the arrow to release it from the wiper arm;

4. Remove the wiper blade;

 When front windshield wiper blade is not mounted, the windshield will be damaged if the wiper arm gets in touch with the windshield. Any damages caused thereof will not be covered by vehicle warranty. ◀

5. Install wiper blades in reversed sequence of Step 2 to 4;
6. Set the vehicle power supply to ON and exit the wiper maintenance mode;
7. Switch wiper adjustment knob to arbitrary gear and the wiper resets.

Replacement of rear windshield wiper blade



1. Pull the rear windshield wiper blade away from the rear windshield;
2. Pull the rear windshield wiper blade in the direction of the arrow and remove it directly;
3. Install rear windshield wiper blade in reversed sequence of step 1 to 2.

Low voltage battery

Maintenance of low-voltage battery

This vehicle is equipped with maintenance free low-voltage batteries.



Low-voltage battery posts, terminals and related accessories contain lead and lead compounds which can affect health. After contact, neutralize with soap and rinse thoroughly with water. ◀

To extend service life of low-voltage battery and maintain normal operation of electric systems of the vehicle, please pay attention to the following recommendations:

- Prevent the low-voltage battery from discharging fully to avoid electrolyte being frozen when driving in a cold area.
- Prevent the low-voltage battery being excessively charged or being short of electricity for a long term.
- It is necessary to charge the low-voltage battery from external power supply when the battery is under voltage.
- Keep the low-voltage battery away from heat source and open fire. When charging or using the battery, keep the place ventilated to prevent burning and hurting people.
- To prevent long-time large current discharge of the low-voltage battery, the start-up time should not be greater than 5 seconds per use. The interval between two consecutive start-ups should be between 10 and 15 seconds.
- The low-voltage battery shall be installed on the vehicle firmly to reduce vibration.
- Inspect whether fastening clamps of low-voltage battery terminals are firm and contact well, for the purpose of preventing sparks and battery explosion caused by such sparks. Get rid of oxide and sulfate produced on fastening clamps of the battery and apply petroleum jelly on the clamps.
- As vehicle circuit system will have little electric current consumption when vehicle is parked, the electricity of low-voltage battery may be run out if vehicle is parked for long time. Therefore, it is necessary to remove black negative (-) cable on low-voltage battery to prevent voltage battery discharging in case of storing vehicle for long time.
- The vehicle should be stored in a cool, ventilated, clean and dry environment. If the vehicle is parked in an enclosed and humid environment for a long time, the rust and aging of vehicle parts will be accelerated. Please follow the recommendations and requirements in the "Warranty and Maintenance Manual" to carry out regular maintenance on the vehicle in a timely manner.

Replacement of low-voltage battery

Be sure to use the low-voltage battery of the same model and specifications when replacing the low voltage battery. Please contact Geely Service to remove, replace and install the low-voltage battery for you.



After replacing low-voltage battery, it is necessary to hand over used low-voltage battery to Geely Service for disposal or deliver to recycle bin meeting relevant environmental protection laws. There is corrosive acid liquor in battery. There is

1

2

3

4

5

6

7

8

corrosive acid liquor in low-voltage battery. Please keep right side up when transporting and storing. ◀



Low-voltage battery electrolyte can cause burns, and the resulting gas is explosive. It may result in personal injury and death. ◀

Power battery

Power battery

As one of the main power sources, power battery can be charged and discharged for many times. Charging methods mainly include external power supply charging and energy recuperating charging.



In order to keep the power battery in the best condition, if the storage period of the vehicle exceeds three months, or if the battery meter indicates that the power is too low, the power battery must be charged, otherwise it may cause excessive discharge of the power battery and reduce the performance of the power battery. The vehicle failure and damage caused thereby will not be guaranteed. ◀

Cautions

Power battery belongs to high-voltage energy storage equipment and dangerous goods. Non professionals and improper operation and use may cause electric shock, combustion, explosion and other serious consequences.

It is strictly forbidden for non professionals to install and maintain power batteries and use them beyond the scope. They must be operated by professional technicians of Geely Service. The power battery damage and other losses caused by failure to use as required or use beyond the specified range will not be warranted.

1. Moisture proof and waterproof

There are many high-voltage control lines and single batteries in the power battery, so it is necessary to ensure that

the power battery will not be immersed in various liquids and wet air.

2. Environmental insulation

When the vehicle is parked, the surrounding area shall be insulated and ventilated to extend the service life of the power battery and improve the safety performance of the power battery.

3. Shockproof and anti-collision

Drive carefully when the road condition is poor to prevent the power battery from bumping and damage.

Recycling process

Please contact Geely Service for maintenance to recycle the power battery according to laws.

 Do not sell, transfer or modify power batteries. Geely Service shall be responsible for recycling the power battery to prevent accidents. ◀

 If the power battery is not properly recovered, the following conditions may occur, causing serious casualties:

- Illegal scrapping or disposal of power batteries will cause harm to the environment, and some people may suffer electric shock due to touching high-voltage parts.
- If the power battery is used improperly or modified, electric shock, heat, smoke, explosion, electrolyte leakage and other accidents may occur. ◀

Tire

Tire maintenance

Tire inspection

When to Check Tire

Check tires at least once a month.

How to Check Tires

Use a high-quality compact tire pressure gauge to check the tire pressures. Inspect tire inflation pressure when the tire temperature is low. Remove the valve cap from the tire valve core. Press the tire pressure gauge firmly on the valve, measure the pressure and read it. If the cold tire inflation pressure complies with recommended pressure value on tire pressure label, it is unnecessary to make adjustment. If the inflation pressure is too low, continue inflating to the recommended pressure value. If the tire is inflated excessively, press the metal valve core of the tire valve to deflate. Inspect the tire pressure again with a tire pressure gauge. Always install the valve cap back on the valve core. The valve cap can prevent dust and moisture from entering the tire.

Tire wear



1

2

3

4

5

6

7

8

The tread wear indicator will appear when the tire tread is worn to 1.6 mm or less. After the tire wear reaches the limit, replace the tire as soon as possible.

If the tire is found to be worn unevenly or you feel some continuous vibration while driving, go to the Geely Automobile Service for inspection. When installing new tires, be sure to perform tire dynamic balancing.



If the tires with shallow tread patterns or exposed wear marks are used continuously, it will lead to extended braking distance, steering failure, tire breakage, etc., which is easy to cause accidents. ◀



Please dispose of used tires in accordance with relevant environmental protection laws. ◀

Tire pressure

Type I



Tire pressure labels are posted on this vehicle. This label is located on the outside of the left center pillar and indicates the air pressure of the front and rear wheels of the vehicle.

Type II



Tire pressure labels are posted on this vehicle. This label is located on the outside of the right center pillar and indicates the air pressure of the front and rear wheels of the vehicle.



Tires can work effectively only when they have correct inflation pressure. Under inflation or over inflation may adversely affect the service life of the tires and the handling performance of the vehicle, causing the vehicle to lose control. ◀

Tire pressure monitoring system (TPMS)

The tire pressure monitoring system alerts the driver to check the tire pressure by turning on the abnormal tire pressure warning lamp.

If the abnormal tire pressure warning lamp is on, it indicates that one or more tires have abnormal tire pressure. Then, stop the vehicle as soon as possible, check the tire pressure and inflate the tire to the correct tire pressure. The cold tire pressure is marked at the tire pressure label on the

vehicle. The vehicle's tire pressure monitoring system can warn of abnormal tire pressure, but it cannot replace normal tire maintenance.

 When the vehicle is driving in winter, if all four tires are replaced with snow tires (the sensors are not installed on the tires), the instrument cluster will prompt that the sensors are missing and give a system failure alarm. ◀

Tire transposition

The tires shall be transposed after each travel of 10,000 km.

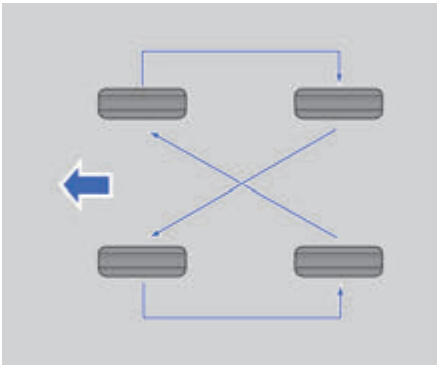

Carry out correct transposition according to the sequence shown in the figure. Adjust inflation pressure of front/rear tires as shown in tire pressure label on the vehicle after tire transposition.

 The wheels need to be installed correctly. After the tire is rotated, please adjust the tire pressure. ◀

Wheel alignment and wheel balance

In case of abnormal tire wear or vehicle deviation, check the wheel alignment. It is

necessary to re-balance tires and wheels if the vehicle jolts when running on smooth road surface. Please contact Geely Automobile Service for maintenance as soon as possible.

Flat tire

The following conditions will occur when the tire blows while the vehicle is driving. Corresponding measures shall be taken according to different conditions:

1. If a front tire bursts, the dragging of the flat tire will cause the vehicle to deflect towards the side of the burst tire. Please release accelerator and hold the steering wheel tightly. Make a turn to keep the vehicle on the original lane, then depress the brake pedal gently to park the vehicle on a safe road as possible as you can.
2. Please release the accelerator if a rear tire bursts. Turn steering wheel to your expected running direction to maintain the vehicle under control. Vehicle may jolt and there will be noise, but the steering still can be controlled. And then depress the brake pedal gently to park the vehicle on a safe road as possible as you can.

If you find that the tire is leaking slowly, please follow the steps below:

1. Drive the vehicle slowly to a safe and flat place to avoid further damage to the tires and wheels.
2. Turn on the hazard warning lamp and place a warning triangle at an appropriate position.
3. Replace tire(s).

1

2

3

4

5

6

7

8



To prevent the vehicle from moving, it is necessary to take the following measures:

- Activate the parking brake.
- Place the vehicle in the Park (P)/Neutral (N) gear.
- Do not allow occupants to sit in the vehicle.
- Before changing the wheel, place blocks at the front and back of other tires. ◀

Vehicle cleaning

Exterior cleaning

Washing the vehicle frequently helps to protect the appearance of the vehicle. When washing the vehicle, you must first turn off the vehicle power and park the vehicle in a cool place. Never wash it under direct sunlight. If the vehicle is left under direct sunlight for a long time, you need to wait for the body surface to cool down before cleaning.

When using an automatic car washer, be sure to follow the instructions of the car washer operator.

 To prevent damage to the vehicle paint, the corrosive substances (bird droppings, resin, insects, asphalt spots, paving salt, industrial dust, etc.) should be removed immediately. If necessary, use industrial alcohol to remove asphalt spots and stubborn oil stains, and then immediately wash with water and mild neutral soap to remove alcohol. ◀

Cleaning the vehicle with high-pressure washer

- Before washing the vehicle, check and confirm that the charging port cover of the vehicle has been properly closed.
- Be sure to clean the vehicle in strict accordance with the instructions for use of the high-pressure washer, paying special attention to the working pressure and spraying distance. If a pressure washer is used, the nozzle must be at least 30cm away from the body surface. Keep the nozzle moving and do not spray water constantly at one position.

High-pressure water flowing into the vehicle parts may cause chronic damage. Do not spray the nozzle towards the charging port.

- Do not use "cluster nozzles" to clean the vehicle.
- Never flush with the nozzle directly or indirectly targeting inside the front compartment. High-pressure water flow can cause damage to the electrical components in the front engine compartment or cause some parts to not work normally.
- Do not aim the nozzle of the water gun at the chassis connector of the disc for flushing (especially connect the orange high-voltage harness connector).
- Do not use a high-pressure washer or a steam washer to clean the front camera or sensor, so as to avoid damage.
- Do not spray to wash the painted bumpers or soft parts, such as rubber hoses, plastic parts, and insulating materials at close range.

Clean the vehicle with automatic car washer

- Before the automatic vehicle washing, please check with the car washer operator to determine whether there are additional parts mounted in the vehicle, and follow the professional advice provided by the operator.
- Fold the exterior rearview mirrors before washing the vehicle.
- The strength of the paint surface of the vehicle body can withstand the washing of the automatic washer, but the impact on the paint surface must be noted. The

1

2

3

4

5

6

7

8

degree of influence mainly depends on the structure of the washer, the cleaning brush, the filtering state of the cleaning water, and the type of cleaning agent and wax solvent. If the paint surface of the vehicle body is darkened or scratched after washing, the operator should be notified immediately to make corrections.

- When choosing an automatic car washer to clean the vehicle, give priority to a non-contact car washer. This type of the vehicle washer does not have any part (brushes, etc.) that may touch the vehicle surface.

Interior cleaning

Regular vehicle interior cleaning helps to improve the environment inside the vehicle. Dust and dirt will accumulate on interior trims, and cause damage to carpet, fabrics, leather and plastic product surfaces. Stains should be cleaned quickly, especially on light-colored interior trims, as they may become solid rapidly under extremely high temperature.

Remove dust on small buttons and knobs with a handy banister brush.

Only use professional cleaning agent to clean the interior trim surface of the vehicle, otherwise it may cause permanent damage to the vehicle. To avoid spraying excessively, it is necessary to spray cleaning agent on the cleaning cloth directly. It is necessary to wipe the clean agent off immediately if you spray it on the surface of other objects in the vehicle by accident.

The temperature of the baking gun used to paste the glass protective film is extremely high. It should be noted that the baking gun should never bake the interior trims when

the protective film is being pasted, otherwise the interior trims will be damaged.

 When cleaning the glass surface on the vehicle, do not use abrasive cleaner, otherwise the glass will be scratched or the rear window defogger will be damaged. Only use soft cloth and glass cleaning agent. ◀

Detergent contains solvent which may coagulate on vehicle interior trims. Please read and comply with all safety instructions on labels before using detergent.

Please open doors and windows to keep good ventilation when cleaning vehicle interior trims.

Please note the following when cleaning the interior trims:

- Do not get rid of dirt on trim surface with a knife blade or other sharp objects.
- Do not use a scrubbing brush. It might damage trim surface of the vehicle.
- Do not press or use cleaning cloth to wipe with great force. Wiping hard cannot improve cleaning effect but will damage the interior trims.
- Only use moderate neutral soap. Avoid using strong detergent or degreasing soap. Too much soap will leave stains and is easy to absorb dirt.
- Do not soak interior trims when cleaning.
- Do not use organic solvents such as naphtha or alcohol, as they will damage interior trim.

Fabric/carpet

Clean dust and scum with vacuum dust catcher fitted with soft broom head. For stubborn stains, you may try to remove

them with fresh water or soda water first. Before cleaning, please choose an appropriate method to remove stains:

- For liquid stains: Wipe residual stains gently with tissue, so that the stains can fully saturate and be absorbed on the tissue.
- For solid stains: Remove as much as possible by hand and then remove with dust catcher.

Cleaning steps:

1. Soak water or soda water with clean lint-free white cleaning cloth.
2. Wring the cleaning cloth to remove residual moisture.
3. When removing stains, scrub gently from edges to middle until no more stain marks are left on the cloth.
4. If stains cannot be wiped off thoroughly, repeat the above cleaning operations with moderate soap water.

If stubborn stains still cannot be removed thoroughly, consider to use synthetic fabric cleaning agent or detergent. Do test for color fastness on an inconspicuous position in the vehicle before using these products. If cleaning effect of the local position is good, they can be used to clean entire surface. After cleaning, the tissue may be used to absorb residual water on fabrics or carpet.

Leather cleaning

Soft cleaning cloth dipped in water may be used to remove dust. To clean more thoroughly, use soft cleaning cloth dipped in neutral soap water. Please let the leather dry in air, do not dry it by baking, and do not clean leather with steam.

Do not use cleaning agent or lustering agent on leather, otherwise the appearance and hand feel of the vehicle interior trims may be permanently changed. Do not use silicon-based, wax-based or organic solvent-containing products to clean the vehicle interior trims, which may cause uneven gloss of leather and affect the appearance of the interior trims. Be sure not to use shoe polish on leather.

Instrument panel and other plastic surfaces

Do not use cleaning agent or lustering agent on plastic surface, otherwise it may change appearance and hand feel of interior trim permanently. Some commercially available products may enhance the glossiness of instrument panel and thus produce annoying reflective light on windshield, which may affect permeability of windshield severely.

1

2

3

4

5

6

7

8

Vehicle identification

Vehicle identification number

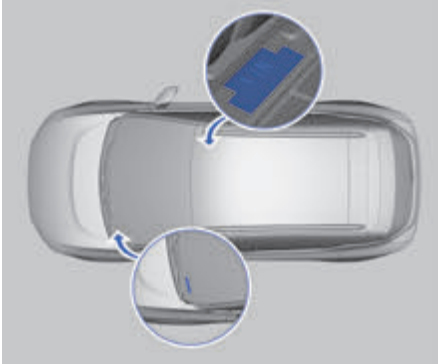

VIN code is engraved on the beam under the front occupant seat. Move the seat back to the end and lift the protective cover. Then it can be seen.

VIN is on the body bracket at the lower left corner of the windshield, which can be seen through the windshield.

 Please provide the VIN when contacting Geely Service. If any damage occurs to the VIN on the vehicle body, please contact Geely Service in time.

Use the Geely vehicle diagnosing instrument to read the vehicle identification code in a Geely Service. Specific steps are as follows:

1. Turn off the vehicle power supply;
2. Connect the Geely vehicle diagnosing instrument to the OBD diagnose interface;
3. Activate the diagnosing program. Start the vehicle, and touch “Welcome” ;
4. Read the VIN automatically.

 To read the VIN, always do it through the Geely Service; otherwise, the vehicle may be damaged. ◀

Vehicle certification label

Type I

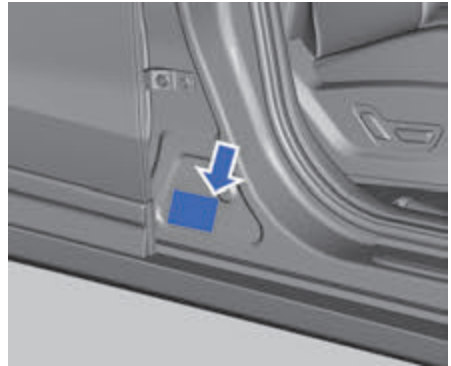

This label contains information such as the vehicle identification code and is located under the right center pillar.

Type II

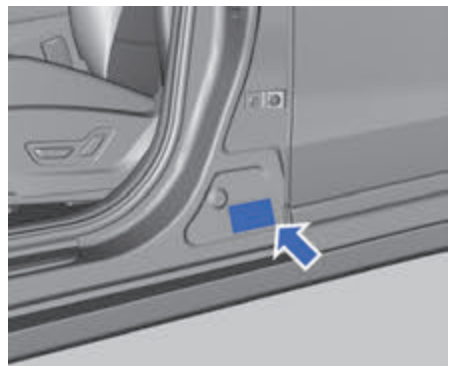

This label contains information such as the vehicle identification code and is located below the left center pillar.

1

2

3

4

5

6

7

8

Driving motor code

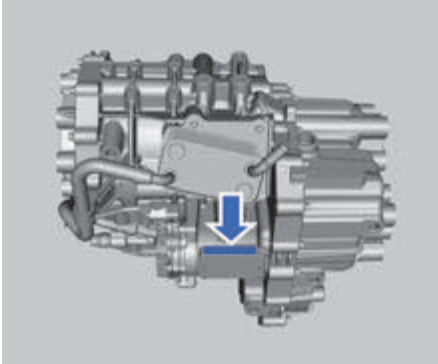

The drive motor code/identification is in the middle of the left side of the bottom of the electric drive system (viewed from the bottom of the vehicle).

1

2

3

4

5

6

7

8

Technical parameters

Main dimensions and parameters

Item	Unit	Parameter
Vehicle length	mm	4432
Vehicle width	mm	1833
Vehicle height	mm	1560 (without luggage rack)/ 1582 (with luggage rack)

Mass parameters of the vehicle

Item	Unit	HP5SEE	LP5SEF
Unladen mass	kg	1630	1685
Unladen front axle mass	kg	900	930
Unladen rear axle mass	kg	730	755
Full load mass	kg	2075	2120
Front axle full load mass	kg	1037	1062
Rear axle full load mass	kg	1038	1058

Power efficiency of the vehicle

Item	Unit	HP5SEE	LP5SEF
Drive type	-	Front-engine, front-wheel-drive layout	Front-engine, front-wheel-drive layout
Maximum vehicle speed	km/h	160	160
Max. gradeability	%	40	40

Drive motor parameters

Item	Unit	HP5SEE	LP5SEF
Model	-	TZ180X, Y150	TZ180X, Y150
Type	-	Permanent magnet synchronous motor	Permanent magnet synchronous motor
Rated power	kW	50	50
Peak power	kW	150	150
Rated torque	N•m	135	135
Peak torque	N•m	310	310
Rated speed	r/min	3537	3537
Peak revolution speed	r/min	15000	15000

Power battery parameters

Item	Unit	HP5SEE	LP5SEF
Type	-	Ternary lithium ion power battery	Ternary lithium ion power battery
Rated voltage	V	353	374
Volume	Ah	150	187

Tire parameters

Item	Parameter	
Tire size	225/50 R17	225/45 R18
Spare tire specification	T125/80 R17	
Dynamic unbalance	≤8 g	
Front tire pressure	240 kPa	250 kPa
Rear tire pressure	240 kPa	250 kPa
Spare tire pressure	420 kPa	

Wheel alignment parameters

Item	Parameters (no load)
Camber angle of front wheel	$-30' \pm 30'$ (right-and-left difference: $\leq 30'$)
Camber angle of rear wheel	$-1^{\circ}19' \pm 30'$ (right-and-left difference: $\leq 30'$)
Kingpin inclination angle	$12^{\circ} \pm 45'$ (right-and-left difference: $\leq 45'$)
Kingpin caster angle	$3^{\circ}54' \pm 30'$ (right-and-left difference: $\leq 30'$)
Front wheel toe-in (bilateral)	$14' \pm 10'$
Rear wheel toe-in (bilateral)	$10' \pm 30'$

1

2

3

4

5

6

7

8

Recommended fluids

Recommended Liquids and Volume

Item	Specification	Volume
Brake fluid	DOT4	0.75L
Windshield washer fluid	-	3.8L
Driving motor and power battery coolant	Geely-approved glycol-type coolant	7.0L
HVAC system coolant	Geely-approved glycol-type coolant	2.4L
A/C refrigerant	R134a	550g
	R1234yf	525g

Index

A

A/C settings	42
Adaptive cruise control system (ACC)*	91
Air monitoring system*	42
Air vent adjustment	41
Airbag	69
Anti-lock braking system (ABS)	124
Appearance overview	9
Automatic emergency braking system (AEB) *	110
Automatic locking and unlocking	16
Automatic speed limit control system (LIM)	89

B

Brake fluid	162
-------------------	-----

C

Central control locking and unlocking	16
Charging operation	132
Charging precautions	132
Child safety lock	18
Coolant	160
Cruise control system (CC)	87

D

Deployment of airbag	72
Door handle unlocking	17
Drive motor anti-theft	14
Drive motor or motor controller overheating	156
Drive motor parameters	178
Driver seat memory function*	25
Driving instructions	81
Driving mode	86
Driving motor code	176

E

Electric power steering (EPS)	127
Electronic brake-force distribution (EBD)	124
Electronic stability control (ESC) system	125
Emergency response to road accidents*	157
Emergency unlocking charger	140
Emergency unlocking door	139
Emergency unlocking trunk door	139
Exterior cleaning	171
Exterior rearview mirror	51

F

Fire extinguisher	138
First aid kit	138
Front A/C control system	37
Front engine compartment fuse box	149
Front seats	21
Front storage	59

G

Gear information	85
Getting vehicle out of trap	157
Graphics	8

H

Hazard warning lamp	137
Heads up display (HUD)	35
Hill descent control (HDC)	126
Hill hold control (HHC)	126
Horn	49
Hydraulic brake assist (HBA)	125

I

Inspection or replacement of fuse ...	148
Installation of child restraint system ...	77
Instrument cluster overview	27
Intelligent cruise control system (ICC) *	100
Intelligent driving system introduction	87
Intelligent high beam control system (IHBC)*	119
Interior cleaning	172
Interior fuse box	152
Interior lighting	47
Interior overview.....	10
Interior rearview mirror	54

J

Jumper starting	142
-----------------------	-----

K

Keyless locking and unlocking.....	14
------------------------------------	----

L

Lane keeping assist (LKA)*.....	107
Light combination switch	43
Luggage rack*	64

M

Main dimensions and parameters ...	177
Maintenance of low-voltage battery	165
Mass parameters of the vehicle	177

N

Notes to users	5
----------------------	---

O

Open and close the front engine hood.....	159
--	-----

Outdoor lamp	48
Overview of front engine compartment	11
Overview of high-voltage system	12

P

Panoramic image system*	130
Panoramic sunroof	57
Park assist system.....	127
Parking brake	122
Positions of airbags	69
Power battery	166
Power battery parameters	178
Power efficiency of the vehicle	177
Power supply mode	19
Power window	55
Preface	1
Prompt message	8

R

Rear seats	23
Rear side radar assist system	116
Rear storage	61
Recommended Liquids and Volume	180
Recuperating.....	121
Reflective vest	137
Regular maintenance	159
Remote locking and unlocking.....	16
Replace the key battery	141
Replacement of bulb	155
Replacement of spare tire	145
Replacement of wiper blade.....	163
Reversing visual system	128

S

Seat belt overview	65
Seat heating/ventilation*	24
Selection of child safety device.....	74
Service brake	121
Shift	85
Smart key	13
Starting procedures	84
Steering wheel adjustment	49
Steering wheel button.....	49

Sun visor and makeup mirror 58

T

Three-point seat belt 66
Tire maintenance 167
Tire parameters 178
Towing eye 143
Towing tips 143
Traction control system (TCS) 126
Trunk door open 17
Trunk storage 62

U

Use of child restraint system 76

V

Vehicle certification label 175
Vehicle fire 156
Vehicle identification number 175

W

Warning triangle 137
Warnings and indicators 31
Washer fluid 162
Wheel alignment parameters 179
Wiper control combination switch 45
Wired charging 63
Wireless charging* 63



Website: <http://global.geely.com>

Facebook: <https://www.facebook.com/GeelyAutoGlobal>